

**+ WOOD**



# linea plus **1,2 mm**

La linea di tubi specifica per stufe a legna  
Range of flue pipes specially designed for  
wood stoves





# PLUS 1,2 mm

Tubi per stufe a legna porcellanati in nero opaco, nero ultra matt e grigio  
 Plus matt black, ultra matt black and grey vitreous enamelled pipes  
 Tubes émaillés Plus en noir mat, noir ultramat et gris  
 Mattschwarz, ultra mattschwarz und grau emaillierte Plus-Rohre



Nero opaco  
 Matt black  
 Noir mat  
 Mattschwarz

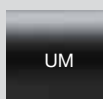

UM

Nero ultra matt  
 Ultramatt black  
 Noir ultramat  
 Schwarz ultramat



Grigio  
 Grey  
 Gris  
 Grau

Rappresentano il massimo qualitativo della produzione SAVE Spa: tubi in acciaio al carbonio saldati a laser per ottenere saldature perfette, vengono successivamente ricoperti internamente ed esternamente con smalto vetroporcellanato cotto a temperatura di 850°C per conferire eccezionali qualità di resistenza alla corrosione delle condense di combustione.

I risultati del test V2 previsto dalla norma 1856-2 sulla resistenza alla corrosione, hanno dimostrato che i canali da fumo Plus 1.2mm e Plus Light hanno una durata decisamente superiore ai normali tubi verniciati di sp. 2mm non vetrificati internamente.

Resistono perfettamente anche a situazioni estreme come il fuoco di fuliggine (incendio che avviene dentro il tubo) senza rovinarsi o alterarsi.

Per evitare la fuoriuscita di condensa è necessario che vengano montati con l'imbocco rivolto verso il basso (vedi disegno). Per fare questo può essere necessario usare come partenza il raccordo F/F anticondensa.

**La Dichiarazione di Prestazioni (DoP) n°2 - Plus 1,2mm è disponibile sul sito [www.savefumisteria.it](http://www.savefumisteria.it) alla pagina "download", con tutti i riferimenti ai test eseguiti e le istruzioni di montaggio e manutenzione a garanzia di assoluta sicurezza nell'utilizzo.**

Representing the highest level of SAVE Spa quality, laser-welding ensures these carbon steel pipes perfect welding. Subsequent internal/external vitreous enamel coating baked to 850°C provides exceptional resistance against corrosion by combustion condensate.

V2 test results specified by corrosion resistance Standard 1856-2 show that Plus 1.2 mm and Plus Light flue pipes have a significantly longer duration than normally painted 2 mm thick pipes that have not received internal vitreous enamel coating.

They are perfectly resistant even to extreme situations such as soot-fire (a fire that occurs inside the pipe) without being damaged or modified.

In order to prevent the leakage of condensate, they must be fitted with the inlet facing downwards (see drawing). To do this, it may be necessary to use an F/F anti-condensate fitting to start with.

**The Declaration of Performance (DoP) n°2 - Plus 1,2mm is available at [www.savefumisteria.it](http://www.savefumisteria.it) in the download area, with reference to all the tests performed and Installation and Maintenance Instructions to ensure the greatest safety during use.**



## DOWNLOAD DoP N°2 - Plus 1,2mm

[www.savefumisteria.it](http://www.savefumisteria.it) > Download

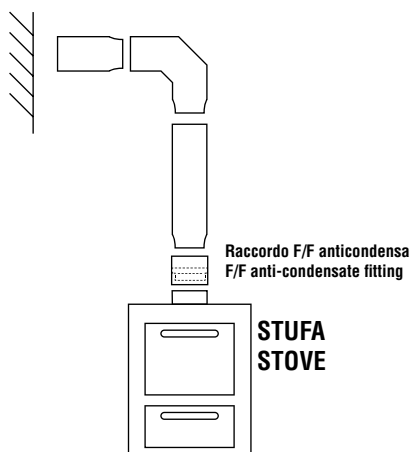

## DESIGNAZIONI - DESIGNATION - DESIGNATION

EN 1856-2 - T600 - N1 - W  
 V2 - L80120 - G600NM

EN 1856-2 - T450 - N1 - W  
 V2 - L80120 - G600NM

EN 1856-2 - T600 - N1 - W  
 V2 - L80120 - O600

EN 1856-2 - T450 - N1 - W  
 V2 - L80120 - O450













# TUBI PLUS 1,2mm

## PORCELLANATI IN NERO OPACO, NERO ULTRA MATT E GRIGIO

• Plus matt black, ultra matt black and grey vitreous enamelled pipes

• Tubes émaillés Plus en noir mat, noir ultra mat et gris

• Mattschwarz, ultra mattschwarz und grau emailierte Plus Rohre

Øcm	color	L 100 cm		L 50 cm		L 25 cm	
		cod.		cod.		cod.	
10		NNO1000	4	NNO1001	4	NNO1002	4
12		NNO1200	4	NNO1201	4	NNO1202	4
12,5		NNO12500	4	NNO12501	4	NNO12502	4
		UU12500	4	UU12501	4	UU12502	4
13		NNO1300	4	NNO1301	4	NNO1302	4
14		NNO1400	4	NNO1401	4	NNO1402	4
15		NNO1500	4	NNO1501	4	NNO1502	4
		UU1500	4	UU1501	4	UU1502	4
		GGO1500	1	GGO1501	1	GGO1502	1
15,3		NNO15300	4	NNO15301	4	NNO15302	4
16		NNO1600	1	NNO1601	1	NNO1602	1
18		NNO1800	1	NNO1801	1	NNO1802	1
		GGO1800	1	GGO1801	1	GGO1802	1
20		NNO2000	1	NNO2001	1	NNO2002	1

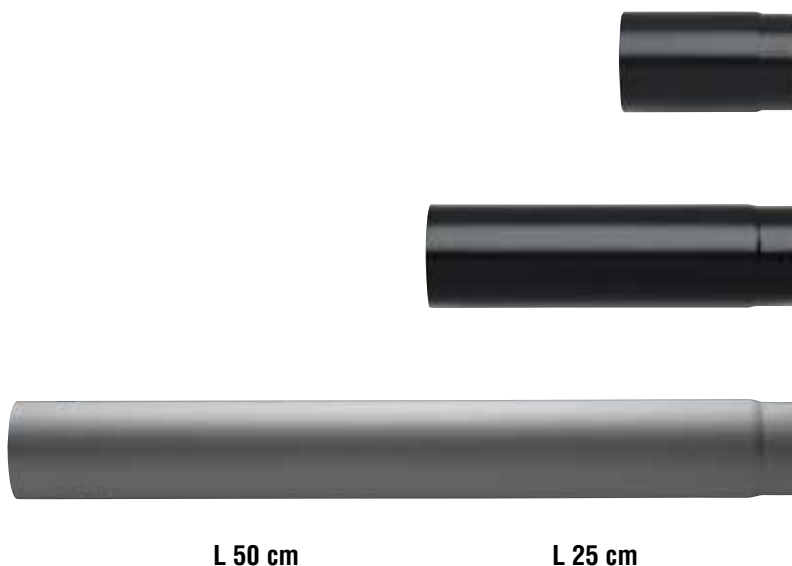



# TUBI TELESCOPICI h 50cm e h 33cm PLUS 1,2mm

## PORCELLANATI IN NERO OPACO, NERO ULTRA MATT E GRIGIO

• Plus matt black, ultra matt black and grey vitreous enamelled telescopic pipes h. 50 cm and h. 33 cm

• Tubes émaillés télescopiques Plus h 50 cm et h 33 cm en noir mat, noir ultra mat et gris

• Ausziehbare emailierte Plus Rohre (h 50 cm und h 33 cm) in mattschwarz, ultra mattschwarz und grau

Øcm	color	H 50 cm		H 33 cm	
		cod.		cod.	
12		-	-	NNO1220	1
12,5		NNO12521	1	NNO12520	1
	UM	-	-	UU12520	1
13		-	-	NNO1320	1
14		-	-	NNO1420	1
15		NNO1521	1	NNO1520	1
	UM	-	-	UU1520	1
		GGO1521	1	GGO1520	1
15,3		NNO15321	1	NNO15320	1
16		-	-	NNO1620	1
18		NNO1821	1	NNO1820	1
		GGO1821	1	GGO1820	1
20		NNO2021	1	NNO2020	1









# TUBI CON ISPEZIONE PLUS 1,2mm

## PORCELLANATI IN NERO OPACO

• Plus matt black vitreous  
enamelled pipes with inspection

• Tubes émaillés Plus  
en noir mat avec trappe de visite

• Mattschwarz emailierte Plus  
Rohre und Reinigungsöffnung

Øcm	color	L 100 cm		L 50 cm		L 33 cm	
		cod.		cod.		cod.	
10		NNO10008	4	NNO10018	4	NNO10028	4
12,5		NNO125008	1	NNO125018	1	NNO125028	1
15		NNO15008	1	NNO15018	1	NNO15028	1
18		NNO18008	1	NNO18018	1	NNO18028	1





















## GOMITI PLUS 1,2mm

## PORCELLANATI IN NERO OPACO, NERO ULTRA MATT E GRIGIO

• Plus matt black, ultra matt black and grey vitreous enamelled 90°, 45°, 30° and 15° elbows

• Coudes émaillés Plus 90°, 45°, 30° et 15° en noir mat, noir ultra mat et gris

• Mattschwarz, ultra mattschwarz und grau emailierte Plus Knie mit 90°, 45°, 30°, 15°-Winkel

Øcm	color	90°		45°		30°		15°	
		cod.		cod.		cod.		cod.	
10		NNO1003	4	NNO1004	4	-	-	-	-
12		NNO1203	4	NNO1204	4	-	-	-	-
12,5		NNO12503	4	NNO12504	4	NNO12543	4	NNO12544	4
	UM 	UU12503	4	UU12504	4	-	-	-	-
13		NNO1303	4	NNO1304	4	-	-	-	-
14		NNO1403	4	NNO1404	4	-	-	-	-
15		NNO1503	4	NNO1504	4	NNO1543	4	NNO1544	4
	UM 	UU1503	4	UU1504	4	-	-	-	-
		GGO1503	1	GGO1504	1	-	-	-	-
15,3		NNO15303	4	NNO15304	4	-	-	-	-
16		NNO1603	1	NNO1604	1	-	-	-	-
18		NNO1803	1	NNO1804	1	-	-	-	-
		GGO1803	1	GGO1804	1	-	-	-	-
20		NNO2003	1	NNO2004	1	-	-	-	-



90°



45°



30°



15°















# GOMITI CON ISPEZIONE PLUS 1,2mm

## PORCELLANATI IN NERO OPACO, NERO ULTRA MATT E GRIGIO

• Plus matt black, ultra matt black and grey vitreous enamelled 90° with inspection elbows

• Coudes émaillés Plus 90° avec trappe de visite et 45° avec trappe de visite en noir mat, noir ultra mat et gris

• Mattschwarz, ultra mattschwarz und grau emailierte Plus Knie mit 90°- und 45° -Winkel und Reinigungsöffnung

Øcm	color	90°		45°	
		cod.		cod.	
10		NNO1008	4	NNO10048	4
12		NNO1208	4	-	-
12,5		NNO12508	4	NNO125048	1
13		NNO1308	4	-	-
15		NNO1508	4	NNO15048	1
		UU1508	4	-	-
		GGO1508	1	-	-
15,3		NNO15308	4	-	-
16		NNO1608	1	-	-
18		NNO1808	1	NNO18048	1



90° ISPEZ.



45° ISPEZ.



# TUBI A "T" PLUS 1,2mm

## PORCELLANATI IN NERO OPACO, NERO ULTRA MATT E GRIGIO

• Plus matt black, ultra matt black and grey vitreous enamelled female-female or male-female T-pieces

• Tés émaillés Plus femelle-femelle ou mâle-femelle en noir mat, noir ultra mat et gris

• Mattschwarz, ultra mattschwarz und grau emailierte Plus T-Stücke Innengewinde/Innengewinde











Øcm	color	F/F		M/F	
		cod.		cod.	
12		NNO1205F	1	-	-
12,5		NNO12505F	1	NNO12505M	1
	UM	UU12505F	1	UU12505M	1
13		NNO1305F	1	-	-
14		NNO1405F	1	-	-
15		NNO1505F	1	NNO1505M	1
	UM	UU1505F	1	UU1505M	1
		GGO1505F	1	-	-
15,3		NNO15305F	1	-	-
18		NNO1805F	1	NNO1805M	1
		GGO1805F	1	-	-
20		NNO2005F	1	-	-





# TAPPI CON CHIUSURA IN SILICONE PER TUBI A "T" PLUS 1,2mm PORCELLANATI IN NERO OPACO E GRIGIO

- Plus matt black and grey vitreous enamelled plugs for T-pieces with silicon plug
- Tampons émaillés Plus en noir mat et gris pour téés avec bouchon en silicone
- Mattschwarz und grau emailierte Plus Verschlussstücke für T-Stücke mit Silikonverschluss

Øcm	color	cod.	
12		<b>NNO1219 *</b>	1
12,5		<b>NNO12519 *</b>	1
13		<b>NNO1319 *</b>	1
14		<b>NNO1419 *</b>	1
15		<b>NNO1519 *</b>	1
		<b>GGO1519 *</b>	1
15,3		<b>NNO15319 *</b>	1
18		<b>NNO1819 *</b>	1
		<b>GGO1819 *</b>	1
20		<b>NNO2019 *</b>	1



**\* Disponibile fino ad esaurimento scorte • Available till sold out • Disponible jusqu'à épuisement du stock • Solange vorrat reicht**













# TAPPI CIECHI PER TUBI A "T" PLUS 1,2mm

PORCELLANATI IN NERO OPACO, NERO ULTRA MATT E GRIGIO

• Plus matt black, ultra matt black and grey vitreous enamelled Blind covers for plus 1.2mm T-pieces

• Tampons borgnes pour tés plus 1,2mm émaillés en noir mat, noir ultra mat et gris

• Mattschwarz, ultra mattschwarz und grau emailierte Blindstopfen für T-Stücke plus 1,2mm

Øcm	color	cod.	
12		NNO1219C	1
12,5		NNO12519C	1
	UM 	UU12519C	1
13		NNO1319C	1
14		NNO1419C	1
15		NNO1519C	1
	UM 	UU1519C	1
		GGO1519C	1
15,3		NNO15319C	1
18		NNO1819C	1
		GGO1819C	1
20		NNO2019C	1



**ATTENZIONE:** I nuovi tappi andranno a sostituire i vecchi tappi con chiusura in silicone una volta esauriti.

**NOTICE:** The new covers will replace the old ones with silicone plug once supplies of the latter have been depleted.



**ATTENTION:** Les nouveaux tampons remplaceront les vieux tampons avec bouchon en silicone une fois qu'ils sont épuisés.

**ACHTUNG:** Die neuen Stopfen ersetzen die alten Stopfen mit Silikonverschluss, welche erhältlich bleiben so lange Vorrat reicht.

# TUBI PER DISASSAMENTO PLUS 1,2 mm

## PORCELLANATI IN NERO OPACO

- Matt black vitreous enamelled blind covers for plus 1.2mm T-pieces
- Tampons borgnes pour tés plus 1,2mm émaillés en noir mat
- Mattschwarz emaillierte Blindstopfen für T-stücke plus 1,2mm



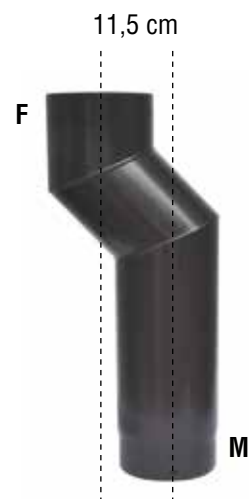







Øcm	color	cod.	
12,5		NNO125OFF	1
15		NNO15OFF	1



# TUBI CON SERRANDA h 25cm PLUS 1,2mm

## PORCELLANATI IN NERO OPACO

- Plus matt black and vitreous enamelled pipes with flue damper h. 25 cm.
- Tubes émaillés Plus en noir mat avec registre h 25 cm
- Mattschwarz emaillierte Plus Rohre mit Schieber, h 25 cm

Øcm	color	cod.	
10		NNO1006	1
12		NNO1206	1
12,5		NNO12506	1
13		NNO1306	1
14		NNO1406	1
15		NNO1506	1
15,3		NNO15306	1
16		NNO1606	1
18		NNO1806	1
20		NNO2006 *	1



\* Disponibile fino ad esaurimento scorte • Available till sold out • Disponible jusqu'à épuisement du stock • Solange vorrat reicht



# RACCORDI PLUS 1,2mm

## PORCELLANATI IN NERO OPACO, NERO ULTRA MATT E GRIGIO

• Plus matt black, ultra matt black and grey vitreous enamelled female-female or male-male fittings h. 12 cm.

• Raccords émaillés Plus femelle-femelle ou mâle-mâle h 12 cm en noir mat, noir ultra mat et gris

• Mattschwarz, ultra mattschwarz und grau emailierte Plus Anschlussstücke Innengewinde/Innengewinde oder Außengewinde/Außengewinde (h 12 cm)

Øcm	color	F/F		M/M	
		cod.		cod.	
10		NNO1017F	2	NNO1017M	2
12		NNO1217F	2	NNO1217M	2
12,5		NNO12517F	2	NNO12517M	2
	UM	UU12517F	2	UU12517M	2
13		NNO1317F	2	NNO1317M	2
14		NNO1417F	2	NNO1417M	2
15		NNO1517F	2	NNO1517M	2
	UM	UU1517F	2	UU1517M	2
		GGO1517F	2	GGO1517M	2
15,3		NNO15317F	2	NNO15317M	2
16		NNO1617F *	2	NNO1617M *	2
18		NNO1817F	2	NNO1817M	2
		GGO1817F	2	GGO1817M	2
20		NNO2017F	2	NNO2017M	2



F/F



M/M

\* Disponibile fino ad esaurimento scorte • Available till sold out • Disponible jusqu'à épuisement du stock • Solange vorrat reicht

+ WOOD



# linea plus **LIGHT**

Leggeri ed economici mantengono tutte le caratteristiche e le prestazioni della linea plus.

Lightweight and economical, they continue to offer all the characteristics and performance of the plus line.







# PLUS LIGHT

Tubi per stufe a legna porcellanati in nero opaco  
 Plus matt black vitreous enamelled pipes  
 Tubes émaillés Plus en noir mat  
 Mattschwarz emaillierte Plus-Rohre



Questi tubi sono più leggeri ed economici rispetto alla linea Plus 1,2mm, pur mantenendo tutte le caratteristiche normative e prestazionali. Sono perfettamente compatibili sia dal punto di vista tecnico per imbrocchi e dimensioni, sia dal punto di vista estetico per l'uguale finitura in smalto porcellanato. Su questi tubi si possono utilizzare gomiti e T della linea Plus 1,2mm oppure gomiti della linea Classic.

Rappresentano il massimo qualitativo della produzione SAVE Spa: tubi in acciaio al carbonio saldati a laser per ottenere saldature perfette, vengono successivamente ricoperti internamente ed esternamente con smalto vetroporcellanato cotto a temperatura di 850°C per conferire eccezionali qualità di resistenza alla corrosione delle condense di combustione.

I risultati del test V2 previsto dalla norma 1856-2 sulla resistenza alla corrosione, hanno dimostrato che i canali da fumo Plus 1.2mm e Plus Light hanno una durata decisamente superiore ai normali tubi verniciati di sp. 2mm non vetrificati internamente.

Resistono perfettamente anche a situazioni estreme come il fuoco di fuliggine (incendio che avviene dentro il tubo) senza rovinarsi o alterarsi.

Per evitare la fuoriuscita di condensa è necessario che vengano montati con l'imbocco rivolto verso il basso (vedi disegno). Per fare questo può essere necessario usare come partenza il raccordo F/F anticondensa.

La Dichiarazione di Prestazioni (DoP) n°6 Plus Light è disponibili sul sito [www.savefumisteria.it](http://www.savefumisteria.it) alla pagina "download", con tutti i riferimenti ai test eseguiti e le istruzioni di montaggio e manutenzione a garanzia di assoluta sicurezza nell'utilizzo.

These pipes are lighter and less expensive than the Plus 1.2mm line, while maintaining all the characteristics and performance standards. They are fully compatible from both the technical point of view - thanks to the same connections and dimensions - and the aesthetical point of view, thanks to the same enamel coating. These pipes can be fitted with Plus 1.2 mm line elbows and tees or Classic line elbows.

Representing the highest level of SAVE Spa quality, laser-welding ensures these carbon steel pipes perfect welding. Subsequent internal/external vitreous enamel coating baked to 850°C provides exceptional resistance against corrosion by combustion condensate.

V2 test results specified by corrosion resistance Standard 1856-2 show that Plus 1.2 mm and Plus Light flue pipes have a significantly longer duration than normally painted 2 mm thick pipes that have not received internal vitreous enamel coating.

They are perfectly resistant even to extreme situations such as soot-fire (a fire that occurs inside the pipe) without being damaged or modified.

In order to prevent the leakage of condensate, they must be fitted with the inlet facing downwards (see drawing). To do this, it may be necessary to use an F/F anti-condensate fitting to start with.

The Declaration of Performance (DoP) n°6 Plus Light is available at [www.savefumisteria.it](http://www.savefumisteria.it) in the download area, with reference to all the tests performed and Installation and Maintenance Instructions to ensure the greatest safety during use.



## DOWNLOAD DoP N°6 - Plus Light

[www.savefumisteria.it](http://www.savefumisteria.it) > Download

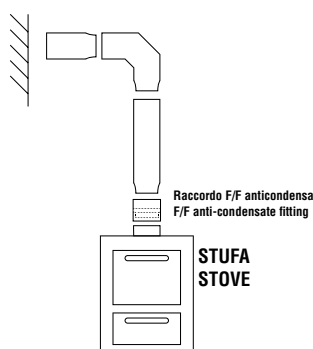

## DESIGNAZIONI - DESIGNATION - DESIGNATION

EN 1856-2 - T600 - N1 - W V2 - L80070 - G600NM	EN 1856-2 - T450 - N1 - W V2 - L80070 - G600NM
EN 1856-2 - T600 - N1 - W V2 - L80070 - O600	EN 1856-2 - T450 - N1 - W V2 - L80070 - O450









# TUBI PLUS LIGHT

## PORCELLANATI IN NERO OPACO

• Plus Light matt black  
vitreous enamelled pipes

• Tubes émaillés Plus Light  
en noir mat

• Mattschwarz emaillierte  
Plus Light Rohre

Øcm	color	L 100 cm		L 50 cm		L 25 cm	
		cod.		cod.		cod.	
12		NNOL1200	6	NNOL1201	6	NNOL1202	6
12,5		NNOL12500	6	NNOL12501	6	NNOL12502	6
13		NNOL1300	6	NNOL1301	6	NNOL1302	6
14		NNOL1400	6	NNOL1401	6	NNOL1402	6
15		NNOL1500	6	NNOL1501	6	NNOL1502	6
15,3		NNOL15300	6	NNOL15301	6	NNOL15302	6



L 100 cm



L 50 cm



L 25 cm







# TUBI TELESCOPICI h 50cm e h 33cm PLUS **LIGHT**

## PORCELLANATI IN NERO OPACO

• Plus Light matt black vitreous enamelled telescopic pipes h. 50 cm and h. 33 cm

• Tubes émaillés télescopiques Plus Light h 50 cm et h 33 cm en noir mat

• Ausziehbare emaillierte Plus Light Rohre (h 50 cm und h 33 cm) in mattschwarz

Øcm	color	H 50 cm		H 33 cm	
		cod.		cod.	
12,5		NNOL12521	1	NNOL12520	1
15		NNOL1521	1	NNOL1520	1
15,3		NNOL15321	1	NNOL15320	1



# GOMITI PLUS 1,2mm

## PORCELLANATI IN NERO OPACO











100% compatible with

**PLUS LIGHT**

• Plus matt black vitreous enamelled  
90°, 45°, 30° and 15° elbows

• Coudes émaillés Plus 90°, 45°,  
30° et 15° en noir mat

• Mattschwarz emailierte Plus Knie  
mit 90°-, 45°-, 30°-, 15°-Winkel

Øcm	color	90°		45°		30°		15°	
		cod.		cod.		cod.		cod.	
12		NNO1203	4	NNO1204	4	-	-	-	-
12,5		NNO12503	4	NNO12504	4	NNO12543	4	NNO12544	4
13		NNO1303	4	NNO1304	4	-	-	-	-
14		NNO1403	4	NNO1404	4	-	-	-	-
15		NNO1503	4	NNO1504	4	NNO1543	4	NNO1544	4
15,3		NNO15303	4	NNO15304	4	-	-	-	-



90°



45°



30°



15°

# GOMITI CON ISPEZIONE PLUS 1,2mm

PORCELLANATI IN NERO OPACO







100% compatible with

**PLUS LIGHT**

• Plus matt black vitreous enameled 90° with inspection and 45° with inspection elbows

• Coudes émaillés Plus 90° avec trappe de visite et 45° avec trappe de visite en noir mat

• Mattschwarz emailierte Plus Knie mit 90°- und 45°-Winkel und Reinigungsöffnung

Øcm	color	90°		45°	
		cod.		cod.	
12		NNO1208	4	-	-
12,5		NNO12508	4	NNO125048	1
13		NNO1308	4	-	-
15		NNO1508	4	NNO15048	1
15,3		NNO15308	4	-	-



90° ISPEZ.



45° ISPEZ.

# TUBI A "T" PLUS 1,2mm

PORCELLANATI IN NERO OPACO









100% compatible with

**PLUS LIGHT**

• Plus matt black vitreous enamelled female-female or male-female T-pieces

• Tés émaillés Plus femelle-femelle ou mâle-femelle en noir mat

• Mattschwarz emailierte Plus T-Stücke Innengewinde/Innengewinde oder Außengewinde/Innengewinde

Øcm	color	F/F		M/F	
		cod.		cod.	
12		NNO1205F	1	-	-
12,5		NNO12505F	1	NNO12505M	1
13		NNO1305F	1	-	-
14		NNO1405F	1	-	-
15		NNO1505F	1	NNO1505M	1
15,3		NNO15305F	1	-	-



# TAPPI CON CHIUSURA IN SILICONE PER TUBI A "T" PLUS 1,2mm PORCELLANATI IN NERO OPACO







100% compatible with

PLUS LIGHT

• Plus matt black vitreous enamelled  
plugs for T-pieces with silicon plug

• Tampons émaillés Plus en noir mat  
pour tés avec bouchon en silicone

• Mattschwarz emailierte Plus Verschlussstücke  
für T-Stücke mit Silikonverschluss

Øcm	color	cod.	
12		NNO1219 *	1
12,5		NNO12519 *	1
13		NNO1319 *	1
14		NNO1419 *	1
15		NNO1519 *	1
15,3		NNO15319 *	1



\* Disponibile fino ad esaurimento scorte • Available till sold out • Disponible jusqu'à épuisement du stock • Solange vorrat reicht

# TAPPI CIECHI PER TUBI A "T" PLUS 1,2mm PORCELLANATI IN NERO OPACO







100% compatible with

PLUS LIGHT

• Matt black vitreous enamelled  
blind covers for T-pieces plus 1.2mm

• Tampons borgnes pour tés  
plus 1,2mm émaillés en noir mat

• Mattschwarz emailierte Blindstopfen  
für T-stücke plus 1,2mm

Øcm	color	cod.	
12		NNO1219C	1
12,5		NNO12519C	1
13		NNO1319C	1
14		NNO1419C	1
15		NNO1519C	1
15,3		NNO15319C	1



**ATTENZIONE:** I nuovi tappi andranno a sostituire i vecchi tappi con chiusura in silicone una volta esauriti.

**NOTICE:** The new covers will replace the old ones with silicone plug once supplies of the latter have been depleted.

**ATTENTION:** Les nouveaux tampons remplaceront les vieux tampons avec bouchon en silicone une fois qu'ils sont épuisés.

**ACHTUNG:** Die neuen Stopfen ersetzen die alten Stopfen mit Silikonverschluss, welche erhältlich bleiben so lange Vorrat reicht.

# RACCORDI PLUS 1,2mm

PORCELLANATI IN NERO OPACO









100% compatible with

PLUS LIGHT

• Plus matt black vitreous enamelled female-female or male-male fittings h. 12 cm.

• Raccords émaillés Plus femelle-femelle ou mâle-mâle h 12 cm en noir mat

• Mattschwarz emaillierte Plus Anschlussstücke Innengewinde/Innengewinde oder Außengewinde/Außengewinde (h 12 cm)

Øcm	color	F/F		M/M	
		cod.		cod.	
12		NNO1217F	2	NNO1217M	2
12,5		NNO12517F	2	NNO12517M	2
13		NNO1317F	2	NNO1317M	2
14		NNO1417F	2	NNO1417M	2
15		NNO1517F	2	NNO1517M	2
15,3		NNO15317F	2	NNO15317M	2



F/F



M/M

# TUBI CON SERRANDA h 25cm PLUS 1,2mm

PORCELLANATI IN NERO OPACO







100% compatible with

PLUS LIGHT

• Plus matt black and vitreous enamelled pipes with flue damper h. 25 cm.

• Tubes émaillés Plus en noir mat avec registre h 25 cm

• Mattschwarz emaillierte Plus Rohre mit Schieber, h 25 cm

Øcm	color	cod.	
12		NNO1206	1
12,5		NNO12506	1
13		NNO1306	1
14		NNO1406	1
15		NNO1506	1
15,3		NNO15306	1



# 2mm VERNICIATO

Tubi in acciaio normale 2mm verniciato in grigio  
 Grey painted 2 mm pipes  
 Tubes 2 mm laqués gris  
 2-mm- Rohre, grau lackiert



Di gradevolissimo aspetto estetico, sono costruiti con lamiera di acciaio di spessore 2mm ed esternamente rivestiti con SENOTHERM®, una speciale vernice per alte temperature che resiste fino a 500°C.

Pleasing to the eye, these pipes are made of sheet steel 2 mm thick and are coated on the outside with SENOTHERM®, a special coating for high temperatures that resists up to 500°C.

**Senotherm®**  
 marchio registrato Weilburger Coatings GmbH

**IMPORTANTE: la condensa** è un fenomeno abbastanza frequente sia per il tipo di stufe su cui si installano (con fumi a basse temperature), sia per l'inerzia termica dei tubi stessi dovuta al loro elevato spessore. Questi canali da fumo sono classificati W, quindi possono essere installati anche in presenza di condensa purchè vengano montati con l'imbocco rivolto verso il basso (vedi disegno). Per fare questo può essere necessario usare come partenza il raccordo anticondensa oppure l'inserito anticondensa.

La Dichiarazione di Prestazioni n°4 - 2mm è disponibile sul sito [www.savefumisteria.it](http://www.savefumisteria.it) alla pagina "download", con tutti i riferimenti ai test eseguiti e le istruzioni di montaggio e manutenzione a garanzia di assoluta sicurezza nell'utilizzo.

**IMPORTANT: condensate** is quite a common occurrence due both to the type of stove on which they are installed (with low temperature smoke) and for the thermal inertia of the pipes themselves caused by their considerable thickness. These flue pipes are classified as W, and, consequently, they can be installed even in the presence of condensate as long as they are fitted with the inlet facing downwards (see drawing). To do this, it may be necessary to use an anti-condensate fitting or an anti-condensate insert to start with.

The Declaration of Performance n°4 - 2mm is available at [www.savefumisteria.it](http://www.savefumisteria.it) in the download area, with reference to all the tests performed and Installation and Maintenance Instructions to ensure the greatest safety during use.



**DOWNLOAD DoP N°4 - 2mm**

[www.savefumisteria.it](http://www.savefumisteria.it) > Download

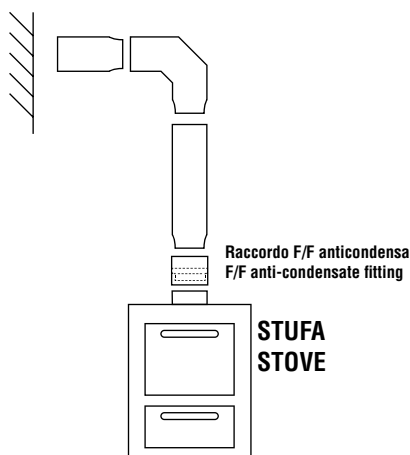

## DESIGNAZIONI - DESIGNATION - DESIGNATION

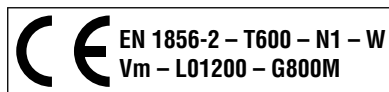







# TUBI 2 mm

## VERNICIATI IN GRIGIO

- Grey painted 2 mm pipes
- Tubes 2 mm laqués gris
- 2-mm-Rohre, grau

Øcm	color	L 100 cm		L 50 cm		L 25 cm	
		cod.		cod.		cod.	
15		GG1500*	1	GG1501*	1	GG1502*	1
18		-	-	GG1801*	1	GG1802*	1





\* Disponibile fino ad esaurimento scorte • Available till sold out • Disponible jusqu'à épuisement du stock • Solange vorrat reicht



# GOMITI 2 mm

## VERNICIATI IN GRIGIO

- Grey painted 2 mm 90° and 45° elbows
- Coudes 2 mm 90° et 45° laqués gris
- 2-mm-Knie mit 90°- und 45°-Winkel, grau lackiert

Øcm	color	90°		45°	
		cod.		cod.	
15		GG1503*	1	GG1504*	1
18		GG1803*	1	GG1804*	1

\* Disponibile fino ad esaurimento scorte • Available till sold out • Disponible jusqu'à épuisement du stock • Solange vorrat reicht

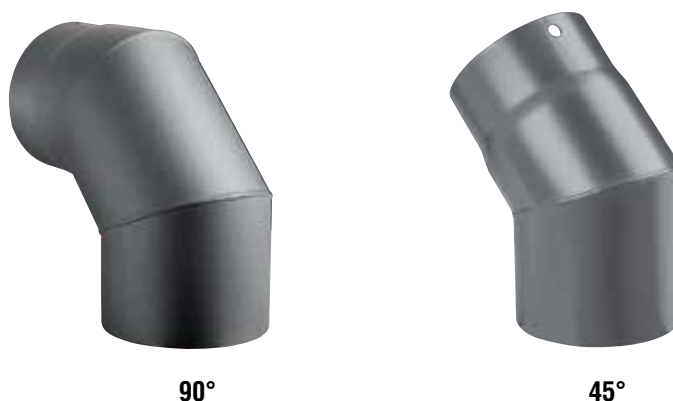



# GOMITI CON ISPEZIONE 2 mm

## VERNICIATI IN GRIGIO

• Grey painted 2 mm  
90° elbows with inspection

• Coudes 2 mm 90° avec trappe de visite  
laqués gris

• 2-mm-Knie mit 90°-Winkel und Reini-  
gungsöffnung, grau lackiert

Øcm	color	cod.	
15		GG1508 *	1
18		GG1808 *	1

\* Disponibile fino ad esaurimento scorte • Available till sold out • Disponible jusqu'à épuisement du stock • Solange vorrat reicht





# TUBI TELESCOPICI h 33cm 2 mm

## VERNICIATI IN GRIGIO

• Grey painted 2 mm  
telescopic pipes h. 33 cm

• Tubes télescopique 2 mm  
h 33 cm laqués gris

• Ausziehbare lackierte 2-mm-Rohre  
(h 33 cm), in grau

Øcm	color	cod.	
15		GG1520 *	1
18		GG1820 *	1

\* Disponibile fino ad esaurimento scorte • Available till sold out • Disponible jusqu'à épuisement du stock • Solange vorrat reicht



# TUBI CON SERRANDA h 25cm 2 mm

## VERNICIATI IN GRIGIO

• Grey painted 2 mm pipes with flue damper h. 25 cm

• Tubes 2 mm laqués gris avec registre h 25 cm

• 2-mm-Rohre, grau lackiert, mit Schieber, h 25 cm

Øcm	color	cod.	
15		GG1506 *	1

\* Disponibile fino ad esaurimento scorte • Available till sold out • Disponible jusqu'à épuisement du stock • Solange vorrat reicht







# RACCORDI 2 mm

## VERNICIATI IN GRIGIO

• Grey painted 2 mm female-female or male-male fittings h. 12 cm

• Raccords 2 mm femelle-femelle ou mâle-mâle h 12 cm laqués gris

• 2-mm-AnschlÜsst¼cke Innengewinde/Innengewinde oder AuÙengewinde/AuÙengewinde, grau lackiert, h 12 cm

Øcm	color	F/F		M/M	
		cod.		cod.	
15		GG1517F *	2	GG1517M *	2
18		GG1817F *	2	GG1817M *	2

\* Disponibile fino ad esaurimento scorte • Available till sold out • Disponible jusqu'à épuisement du stock • Solange vorrat reicht



F/F



M/M

# ACCESSORI PLUS & PLUS **LIGHT** 2mm VERNICIATO

Accessori "PLUS" in nero opaco, nero ultra matt e grigio  
 Matt black, ultra matt black and grey "PLUS" accessories  
 Accessoires "PLUS" en noir mat, noir ultra mat et gris  
 Accessoires Baureihe "PLUS" in mattschwarz, ultra mattschwarz und grau



Nero opaco  
 Matt black  
 Noir mat  
 Mattschwarz

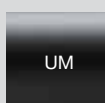

UM

Nero ultra matt  
 Ultramatt black  
 Noir ultramat  
 Schwarz ultramatt



Grigio  
 Grey  
 Gris  
 Grau

Tutti gli Accessori Plus SAVE sono appositamente studiati per essere perfettamente adattabili alle linee Pellet, Pellet Light, Plus 1,2mm, Plus Light, 2 mm verniciati.

All the Plus SAVE accessories have been specifically designed to fit the Pellet, Pellet Light, Plus 1,2mm, Plus Light, 2 mm painted pipes.



**ATTENZIONE:**

Tutti gli accessori verniciati sono compatibili con le finiture smaltate nero opaco e nero ultra matt

**ATTENTION:**

All black painted accessories are compatible with vitreous enamelled finishes in matt black and ultra matt black

**ATTENZIONE:**

Tous les accessoires en peinture noir sont compatibles avec les finitions en emaille noir matt et noir ultra matt

**ACHTUNG:**

Alle schwarz lackierte Zubehöre sind kompatibel mit emallierte Rohre in mattschwarz und ultra mattschwarz















# ANELLI PLUS

## VERNICIATI IN NERO OPACO E GRIGIO

• Matt black and grey painted Plus ring

• Anneaux Plus laqués noir mat e gris

• Mattschwarz und grau lackierte Plus Ringe

Øcm	color	90°		45°	
		cod.		cod.	
10		NN1010	10	-	-
12		NN1210	10	-	-
12,5		NN12510	10	NN12514	10
13		NN1310	10	-	-
14		NN1410	10	-	-
15		NN1510	10	NN1514	10
15,3		GG1510	10	-	-
16		NN1610	10	-	-
18		NN1810	10	-	-
		GG1810	10	-	-
20		NN2010	10	-	-



## KIT FISSAGGIO MAGNETICO PER ANELLI PLUS

• Magnetic fixing kit for rings

• Magnetic kit de montage pour les anneaux

• Magnetischer Montage-Kit für Ringe

cod.	
NNFIX	20













# ROSONI PLUS

## VERNICIATI IN NERO OPACO E GRIGIO

• Matt black and grey painted Plus ring

• Anneaux Plus laqués noir mat e gris

• Mattschwarz und grau lackierte Plus Ringe

Øcm	color	cod.	
12		NN1209	5
13		NN1309	5
14		NN1409	5
15		NN1509	5
		GG1509	5
16		NN1609	5
18		NN1809	5
		GG1809	5
20		NN2009	5













# REGGITUBO PLUS

## VERNICIATI IN NERO OPACO E GRIGIO

• Matt black and grey painted stainless steel Plus pipe holder

• Porte-tubes Plus laqué noir mat et gris

• Mattschwarz und grau lackierter Plus Rohrhalter mit Dübel

Øcm	color	cod.	
10		NN210	10
12		NN212	10
13 - 12,5		NN213	10
14		NN214	10
15 - 15,3		NN215	10
		GG215	10
16		NN216	10
18		NN218	10
		GG218	10
20		NN220	10



















# RIDUZIONI PLUS

## PORCELLANATE IN NERO OPACO E GRIGIO

• Matt black and grey vitreous enameled Plus reducers

• Réductions Plus émaillés noir mat et gris

• Mattschwarz und grau emailierte Plus Reduzierstücke

Øcm	color	cod.	
20F/18M		NNO20F/18M	2
20F/15M		NNO20F/15M	2
18F/15M		NNO18F/15M	2
		GGO18F/15M	2
16F/15M		NNO16F/15M	2
15,3F/15M		NNO153F/15M	2
15F/14M		NNO15F/14M	2
		GGO15F/14M	2
15F/13M		NNO15F/13M	2
15F/12,5M		NNO15F/125M	2
15F/12M		NNO15F/12M	2
14F/13M		NNO14F/13M	2
14F/12M		NNO14F/12M	2
13F/12M		NNO13F/12M	2
12,5F/13M		NNO125F/13M	2

















# RACCORDI F/F ANTICONDENSA PLUS

PORCELLANATI IN NERO OPACO, NERO ULTRA MATT E GRIGIO

• Matt black, ultra matt black and grey vitreous enamelled Plus female-female anti-condensate fittings

• Raccords anticondensation Plus femelle-femelle émaillés en noir mat, noir ultra mat et gris

• Anschlussstücke mit Kondensationsschutz Plus, Innengewinde/Innengewinde, mattschwarz, ultra mattschwarz und grau emailierte

Øcm	color	cod.	
12		NNO1231	2
12,5		NNO12531	2
		UU12531	2
13		NNO1331	2
14		NNO1431	2
15		NNO1531	2
		UU1531	2
		GGO1531	2
15,3		NNO15331	2
18		NNO1831	2
		GGO1831	2
20		NNO2031	2









# SERRANDE PLUS

VERNICIATE IN NERO OPACO E GRIGIO

• Plus matt black and grey painted flue damper

• Registre Plus laqué noir mat et gris

• Plus Schieber, mattschwarz und grau lackiert

Øcm	color	cod.	
12-13		NN12/1315	1
14-15-16		NN14/15/1615	1
		GG14/15/1615	1
18-20		NN18/2015	1
		GG18/2015	1



# RACCORDI TELESCOPICI A SOFFITTO PLUS

## VERNICIATI IN NERO OPACO

• Plus matt black painted telescopic ceiling fittings

• Raccords télescopiques Plus plafond laqués noir mat

• Ausziehbares Plus Deckenanschlussstück, mattschwarz lackiert

Øcm	color	cod.	
15		NN1511	1



# PEDANE





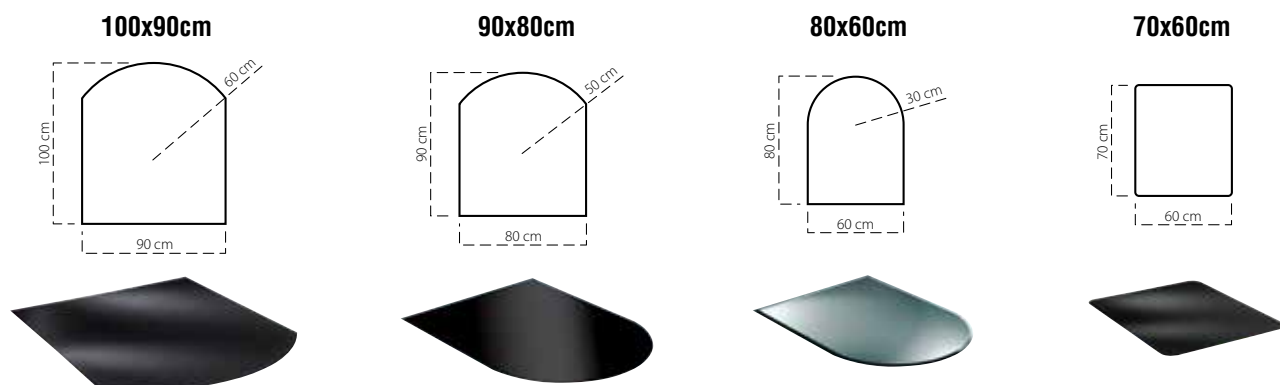

## IN ACCIAIO VERNICIATO NERO OPACO E VETRO TEMPERATO

• Matt black painted steel and toughened glass bases

• Bases en acier laqué noir mat et verre trempé

• Bodenplatten aus mattschwarz lackiertem Stahl und Sekuritglas



Øcm	color	cod.	
100x90		P100/90	1
90x80		P90/80	1
80x60		P80/60	1
		PV80/60 *	1
70x60		P70/60	1

\* Disponibile fino ad esaurimento scorte • Available till sold out • Disponible jusqu'à épuisement du stock • Solange vorrat reicht



# BOMBOLETTE SPRAY PER RITOCCHI

## COLORE NERO OPACO E GRIGIO

• Spray canisters for touch-ups  
(matt black and grey)

• Vaporisateurs pour retouches  
(noir mat et gris)

• Spraydosen zum Nachbessern  
(mattschwarz und grau)

color	cod.	
	NNSPRAY	1
	GGSPRAY	1



# COPPELLE DI COIBENTAZIONE

## IN LANA DI ROCCIA SPESSORE 30mm

• 30 mm thick rock wool  
pipe insulators

• Coupelles d'isolement en laine  
de roche épaisseur 30 mm

• Dämmmantel - Steinwolle,  
Stärke 30 mm

Øcm	cod.	
8	AA815	10
10	AA1015	8
12	AA1215	7
13	AA1315	7
14	AA1415	7
15	AA1515	7



+ WOOD



# linea classic

La tradizione dei prodotti Save.

The traditional SAVE line.



# PORCELLANATI CLASSIC

Tubi e gomiti porcellanati Classic in bianco, marrone e nero opaco  
Classic white, brown and matt black vitreous enamelled pipes and elbows  
Tubes et coudes émaillés Classic en blanc, marron et noir mat  
Weiß, braun und mattschwarz emailierte Classic Rohre und Knie



Bianco  
White  
Blanc  
Weiss



Marrone  
Brown  
Marron  
Braun



Nero opaco  
Matt black  
Noir mat  
Mattschwarz

I tubi smaltati SAVE sono prodotti con lamiera di acciaio rivestita con smalto porcellanato tramite un procedimento che prevede la cottura del pezzo a ben 830°C.

Lo smalto porcellanato rende questo tubo preferibile ad ogni altro per alcune caratteristiche:

- resistenza alle più alte temperature di esercizio: T600, la classe più alta secondo la EN 1856-2
- resistenza allo sbalzo termico
- resistenza alla corrosione da condensa certificata dal superamento del test V2 che li rende idonei all'utilizzo con qualsiasi tipo di combustibile: solido, liquido e gassoso
- resistenza all'abrasione e agli agenti chimici: sono lavabili con qualsiasi solvente o prodotto per la pulizia.
- tenuta ai gas della combustione (tiraggio naturale)
- qualità estetica: i colori non si alterano con l'uso o con le alte temperature

## CAMPO DI APPLICAZIONE

**APPARECCHI E STUFE A: LEGNA - CARBONE - GAS  
GASOLIO - KEROSENE**

La Dichiarazione di Prestazioni (Dop) n°1 - Classic è disponibile sul sito [www.savefumisteria.it](http://www.savefumisteria.it) alla pagina "download", con tutti i riferimenti ai test eseguiti e le istruzioni di montaggio e manutenzione a garanzia di assoluta sicurezza nell'utilizzo.

The SAVE vitreous enamelled pipes are made of sheet steel coated with vitreous enamel and baked at 830°C.

The vitreous enamel coating makes this pipe better than any other pipe thanks to some of its features:

- resistance to the highest working temperatures: T600, the highest class according to EN 1856-2
- resistance to any changes in temperature
- resistance to condensate corrosion certified by the outcome of the V2 test for qualification for use with any type of solid, liquid or gas fuel.
- resistance to abrasion and chemical agents; they can be cleaned with any solvent or cleaning product
- combustion gas-tight (natural draught)
- aesthetic quality: colours do not alter with use or as a result of high temperatures

## FIELD OF APPLICATION

**WOOD-BURNING – COAL – GAS – GAS OIL  
KEROSENE APPLIANCES AND STOVES**

The Declaration of Performance (DoP) n°1 - Classic is available at [www.savefumisteria.it](http://www.savefumisteria.it) in the download area, with reference to all the tests performed and Installation and Maintenance Instructions to ensure the greatest safety during use.





## DOWNLOAD DoP N°1 - Classic

[www.savefumisteria.it](http://www.savefumisteria.it) > Download

## DESIGNAZIONI - DESIGNATION - DESIGNATION

 EN 1856-2 – T600 – N1 – D  
V2 – L80055 – G450NM

 EN 1856-2 – T450 – N1 – D  
V2 – L80055 – G450NM

 EN 1856-2 – T600 – N1 – D  
V2 – L80055 – O450

 EN 1856-2 – T450 – N1 – D  
V2 – L80055 – O350





# TUBI CLASSIC

## PORCELLANATI IN BIANCO, MARRONE E NERO OPACO

• Classic white, brown and matt black vitreous enamelled pipes

• Tubes émaillés Classic en blanc, marron et noir mat

• Weiß, braun und Mattschwarz emailierte Classic Rohre

























L 100 cm



L 50 cm



L 25 cm

Øcm	color	L 100 cm		L 50 cm		L 25 cm	
		cod.		cod.		cod.	
8		<b>B800</b>	12	<b>B801</b>	12	<b>B802</b>	12
		<b>M800</b>	12	<b>M801</b>	12	<b>M802</b>	12
9		<b>B900</b>	12	<b>B901</b>	12	<b>B902</b>	12
10		<b>B1000</b>	12	<b>B1001</b>	12	<b>B1002</b>	12
		<b>M1000</b>	12	<b>M1001</b>	12	<b>M1002</b>	12
		<b>NO1000</b>	12	<b>NO1001</b>	12	<b>NO1002</b>	12
11		<b>B1100</b>	12	<b>B1101</b>	12	<b>B1102</b>	12
		<b>M1100</b>	12	<b>M1101</b>	12	<b>M1102</b>	12
12		<b>B1200</b>	12	<b>B1201</b>	12	<b>B1202</b>	12
		<b>M1200</b>	12	<b>M1201</b>	12	<b>M1202</b>	12
		<b>NO1200</b>	12	<b>NO1201</b>	12	<b>NO1202</b>	12
13		<b>B1300</b>	12	<b>B1301</b>	12	<b>B1302</b>	12
		<b>M1300</b>	12	<b>M1301</b>	12	<b>M1302</b>	12
		<b>NO1300</b>	12	<b>NO1301</b>	12	<b>NO1302</b>	12
14		<b>B1400</b>	6	<b>B1401</b>	6	<b>B1402</b>	6
		<b>M1400</b>	6	<b>M1401</b>	6	<b>M1402</b>	6
		<b>NO1400</b>	6	<b>NO1401</b>	6	<b>NO1402</b>	6
15		<b>B1500</b>	6	<b>B1501</b>	6	<b>B1502</b>	6
		<b>M1500</b>	6	<b>M1501</b>	6	<b>M1502</b>	6
		<b>NO1500</b>	6	<b>NO1501</b>	6	<b>NO1502</b>	6



## GOMITI CLASSIC

## PORCELLANATI IN BIANCO, MARRONE E NERO OPACO

• Classic white, brown and matt black vitreous enamelled 90° and 45° elbows

• Coudes émaillés Classic 90° et 45° en blanc, marron et noir mat

• Weiß, braun und Mattschwarz emaillierte Classic 90°- und 45°-Knie

Øcm	color	90°		45°	
		cod.		cod.	
8		B803	12	B804	12
		M803	12	M804	12
9		B903	12	-	-
10		B1003	12	B1004	12
		M1003	12	M1004	12
		NO1003	12	NO1004	12
11		B1103	12	-	-
		M1103	12	-	-
12		B1203	12	B1204	12
		M1203	12	M1204	12
		NO1203	12	NO1204	12
13		B1303	12	B1304	12
		M1303	12	M1304	12
		NO1303	12	NO1304	12
14		B1403	6	B1404	6
		M1403	6	M1404	6
		NO1403	6	NO1404	6
15		B1503	6	B1504	6
		M1503	6	M1504	6
		NO1503	6	NO1504	6



90°



45°









# TUBI h 25cm CON FORO PER SERRANDA CLASSIC

## PORCELLANATI IN BIANCO, MARRONE E NERO OPACO

• Classic white, brown and matt black vitreous enamelled drilled pipes for flue dampers (h= 25 cm)

• Tubes Classic ayant un trou pour le registre (h=25 cm) en blanc, marron et noir mat

• Emaillierte Classic Rohre mit Öffnung für Schieber (H=25 cm) in weiß, braun und mattschwarz

Øcm	color	cod.	
10		B1006 *	12
		M1006 *	12
		NO1006 *	12
12		B1206	12
		M1206	12
		NO1206	12



\* Disponibile fino ad esaurimento scorte • Available till sold out • Disponible jusqu'à épuisement du stock • Solange vorrat reicht







# DIFFUSORI DI CALORE A 8 CANNE CLASSIC

## PORCELLANATI IN BIANCO, MARRONE E NERO OPACO

• Classic white, brown and matt black vitreous enamelled 8-pipe heaters

• Diffuseurs de chaleur Classic à 8 canneaux émaillés en blanc, marron et noir mat

• Heizelemente mit 8 emaillierten Classic Rohren in weiß, braun und mattschwarz

Øcm	color	cod.	
10		B1007	3
		M1007	3
		NO1007 *	3
12		B1207	3
		M1207	3
		NO1207	3



\* Disponibile fino ad esaurimento scorte • Available till sold out • Disponible jusqu'à épuisement du stock • Solange vorrat reicht





## TUBI A "T" CLASSIC

## PORCELLANATI IN BIANCO E MARRONE

• Classic white and brown vitreous enamelled T-pieces

• Tés Classic émaillés en blanc et marron

• Weiß und braun emailierte, T-förmige Classic Abzweige

Øcm	color	cod.	
12		B1205F	9
		M1205F	9
14		B1405F *	6
15		M1505F *	6

\* Disponibile fino ad esaurimento scorte • Available till sold out • Disponible jusqu'à épuisement du stock • Solange vorrat reicht





## TUBI AD "H" CLASSIC

## PORCELLANATI IN BIANCO E MARRONE

• Classic white and brown vitreous enamelled H-pieces

• Tubes émaillés Classic en forme de H, en blanc et marron

• Weiß und braun emailierte H-förmige Classic Rohre

Øcm	color	cod.	
12		M1208	5
14		B1408 *	4





















\* Disponibile fino ad esaurimento scorte • Available till sold out • Disponible jusqu'à épuisement du stock • Solange vorrat reicht



## ROSONI CLASSIC

VERNICIATI IN BIANCO, MARRONE E NERO OPACO

• Classic covers painted in white,  
brown and matt black• Rosaces Classic laquées blanc,  
marron et noir mat• Weiß, braun und mattschwarz  
lackierte Classic Rosetten

Øcm	color	cod.	
8		B809	10
		M809	10
9		B909	10
10		B1009	10
		M1009	10
		NO1009	10
11		B1109	10
12		B1209	10
		M1209	10
		NO1209	10
13		B1309	10
		M1309	10
		NO1309	10
14		B1409	10
		NO1409	10
15		B1509	10
		NO1509	10
16		B1609	10
18		B1809	10
20		B2009	10



# RIDUZIONI CLASSIC

## VERNICIATE IN BIANCO, MARRONE E NERO OPACO

• Classic white, brown and matt black painted reducers

• Réductions Classic laquées blanc, marron et noir mat

• Weiß, braun und mattschwarz lackierte Classic eduzierstücke

Øcm	color	cod.	
10F/8M		<b>B10/8</b>	25
		<b>M10/8</b>	25
11F/10M		<b>B11/10</b>	25
		<b>M11/10</b>	25
12F/8M		<b>B12/8</b>	25
		<b>M12/8</b>	25
12F/10M		<b>B12/10</b>	25
		<b>M12/10</b>	25
		<b>NO12/10</b>	25
13F/10M		<b>B13/10</b>	20
		<b>M13/10</b>	20
		<b>NO13/10</b>	20
13F/12M		<b>B13/12</b>	20
		<b>M13/12</b>	20
		<b>NO13/12</b>	20
14F/10M		<b>B14/10</b>	20
		<b>M14/10</b>	20
		<b>NO14/10</b>	20
14F/12M		<b>B14/12</b>	20
		<b>M14/12</b>	20
		<b>NO14/12</b>	20
14F/13M		<b>B14/13</b>	20
		<b>M14/13</b>	20
		<b>NO14/13</b>	20
15F/12M		<b>B15/12</b>	15
		<b>NO15/12</b>	15
15F/13M		<b>B15/13</b>	15
		<b>NO15/13</b>	15
15F/14M		<b>B15/14</b>	15
		<b>NO15/14</b>	15

8F/10M		<b>B8/10</b>	25
		<b>M8/10</b>	25
8F/12M		<b>B8/12</b>	20
		<b>M8/12</b>	20
10F/12M		<b>B10/12</b>	20
		<b>M10/12</b>	20
		<b>NO10/12</b>	20









# SERRANDE

## ZINCATE

• Galvanised flue dampers

• Registres galvanisés

• Verzinkte Schieber

Øcm	color	cod.	
10		Z1015	1
11		Z1115 *	1
12		Z1215	1
13		Z1315 *	1
16		Z1615 *	1



\* Disponibile fino ad esaurimento scorte • Available till sold out • Disponible jusqu'à épuisement du stock • Solange vorrat reicht





# REGGITUBO CLASSIC

## VERNICIATI IN BIANCO, MARRONE E NERO

• Classic white, brown and black painted pipe holder

• Porte-tubes à cheville Classic laqué blanc, marron et noir

• Lackierter Classic Rohrhalter mit Dübel in weiß, braun und schwarz

Øcm	color	cod.	
8/13		N28/13	5
10/15		B210/15	5
		M210/15	5
		N210/15	5





# STENDIBIANCHERIA CLASSIC

## VERNICIATI IN BIANCO E MARRONE

• Classic clothes drier in white and brown

• Séchoir à linge Classic en blanc et marron

• Classic Wäschetrockner in weiß und braun

Øcm	color	cod.	
8/14		B5	6
		M5	6

