



LINEA

Wood

La linea di tubi specifica
per stufe a legna

Range of flue pipes specially
designed for wood stoves



LINEA WOOD

Plus 1,2 mm



Tubi per stufe a legna porcellanati
Vitreous enamelled pipes for wood stove
Tubes émaillé pour poêles à bois
Emaillierte Rohre für Holzofen



DoP N°2 - Plus 1,2mm
www.savefumisteria.it > Download

GAMMA COLORI COLOR RANGE

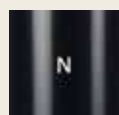

Nero opaco
Matt black
Noir mat
Mattschwarz



Nero ultra matt
Ultramatt black
Noir ultramat
Schwarz ultramatt

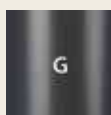

Grigio
Grey
Gris
Grau

CARATTERISTICHE FEATURES

Rappresentano il massimo qualitativo della produzione SAVE Spa: tubi in acciaio al carbonio saldati a laser per ottenere saldature perfette, vengono successivamente ricoperti internamente ed esternamente con smalto vetroporcellanato cotto a temperatura di 850°C per conferire eccezionali qualità di resistenza alla corrosione delle condense di combustione.

I risultati del test V2 previsto dalla norma 1856-2 sulla resistenza alla corrosione, hanno dimostrato che i canali da fumo Plus 1.2mm e Plus Light hanno una durata decisamente superiore ai normali tubi verniciati di sp. 2mm non vetrificati internamente.

Resistono perfettamente anche a situazioni estreme come il fuoco di fuliggine (incendio che avviene dentro il tubo) senza rovinarsi o alterarsi.

La Dichiarazione di Prestazioni (DoP) n°2 Plus 1,2mm è disponibile sul sito www.savefumisteria.it alla pagina "download", con tutti i riferimenti ai test eseguiti e le istruzioni di montaggio e manutenzione a garanzia di assoluta sicurezza nell'utilizzo.

SUL NOSTRO SITO www.savefumisteria.it SONO DISPONIBILI INFORMAZIONI PIÙ DETTAGLIATE SU OGNI SINGOLO PRODOTTO.

Representing the highest level of SAVE Spa quality, laser-welding ensures these carbon steel pipes perfect welding. Subsequent internal/external vitreous enamel coating baked to 850°C provides exceptional resistance against corrosion by combustion condensate.

V2 test results specified by corrosion resistance Standard 1856-2 show that Plus 1.2 mm and Plus Light flue pipes have a significantly longer duration than normally painted 2 mm thick pipes that have not received internal vitreous enamel coating.

They are perfectly resistant even to extreme situations such as soot-fire (a fire that occurs inside the pipe) without being damaged or modified.

The Declaration of Performance (DoP) n°2 Plus 1,2mm is available at www.savefumisteria.it in the download area, with reference to all the tests performed and Installation and Maintenance Instructions to ensure the greatest safety during use.

MORE DETAILED INFORMATION ABOUT EACH PRODUCTS ARE AVAILABLE ON OUR WEBSITE www.savefumisteria.it

ANTICONDENSA ANTI-CONDENSATE

Per evitare la fuoriuscita di condensa è necessario che vengano montati con l'imbocco rivolto verso il basso (vedi disegno). Per fare questo può essere necessario usare come partenza il raccordo F/F anticondensa.

In order to prevent the leakage of condensate, they must be fitted with the inlet facing downwards (see drawing). To do this, it may be necessary to use an F/F anti-condensate fitting to start with.

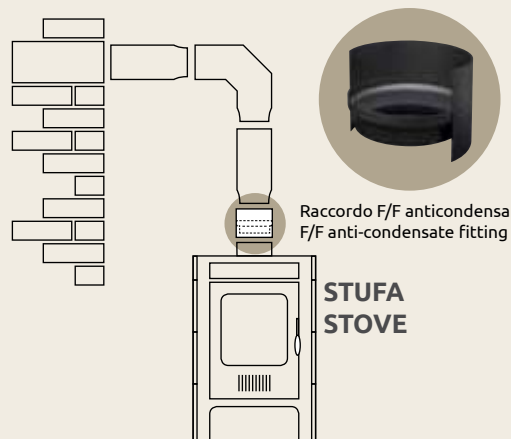

DESIGNAZIONI DESIGNATION

- ⊕ EN 1856-2 – T600 – N1 – W – V2 – L80120 – G600NM
- ⊕ EN 1856-2 – T600 – N1 – W – V2 – L80120 – O600
- ⊕ EN 1856-2 – T450 – N1 – W – V2 – L80120 – G600NM
- ⊕ EN 1856-2 – T450 – N1 – W – V2 – L80120 – O450

Tubi Plus 1,2 mm

porcellanati in nero opaco,
nero ultra matt e grigio

Plus matt black, ultra matt black
and grey vitreous enamelled pipes

Tubes émaillés Plus en noir mat,
noir ultra mat et gris

Mattschwarz, ultra mattschwarz und grau
emaillierte Plus Rohre

Øcm	color	L 100cm		L 50cm		L 25cm	
		cod.	Pack	cod.	Pack	cod.	Pack
10	N	NNO1000	4	NNO1001	4	NNO1002	4
12	N	NNO1200	4	NNO1201	4	NNO1202	4
12,5	N	NNO12500	4	NNO12501	4	NNO12502	4
	U	UU12500	4	UU12501	4	UU12502	4
13	N	NNO1300	4	NNO1301	4	NNO1302	4
14	N	NNO1400	4	NNO1401	4	NNO1402	4
15	N	NNO1500	4	NNO1501	4	NNO1502	4
	U	UU1500	4	UU1501	4	UU1502	4
	G	GGO1500*	1	GGO1501*	1	GGO1502*	1
15,3	N	NNO15300	4	NNO15301	4	NNO15302	4
16	N	NNO1600	1	NNO1601	1	NNO1602	1
18	N	NNO1800	1	NNO1801	1	NNO1802	1
	G	GGO1800*	1	GGO1801*	1	GGO1802*	1
20	N	NNO2000	1	NNO2001	1	NNO2002	1



Disponibile fino ad esaurimento scorte • Available till sold out • Disponible jusqu'à épuisement du stock • Solange vorrat reicht

Tubi telescopici H50cm e H33cm Plus 1,2 mm

porcellanati in nero opaco,
nero ultra matt e grigio

Plus matt black, ultra matt black and grey vitreous
enamelled telescopic pipes h. 50 cm and h. 33 cm

Tubes émaillés télescopiques Plus h 50 cm et h 33 cm
en noir mat, noir ultra mat et gris

Ausziehbare emailierte Plus Rohre
(h 50 cm und h 33 cm) in mattschwarz,
ultra mattschwarz und grau

		H 50cm		H 33cm	
Øcm	color	cod.	Pack	cod.	Pack
12	N	-	-	NNO1220	1
12,5	N	NNO12521*	1	NNO12520	1
	U	-	-	UU12520	1
13	N	-	-	NNO1320	1
14	N	-	-	NNO1420	1
15	N	NNO1521	1	NNO1520	1
	U	-	-	UU1520	1
	G	GGO1521*	1	GGO1520*	1
15,3	N	NNO15321*	1	NNO15320	1
16	N	-	-	NNO1620*	1
18	N	NNO1821*	1	NNO1820	1
	G	GGO1821*	1	GGO1820*	1
20	N	NNO2021*	1	NNO2020	1

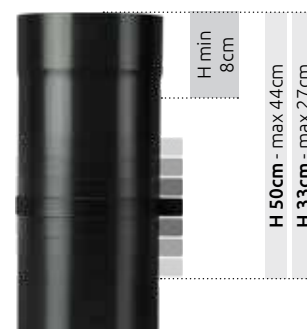

Disponibile fino ad esaurimento scorte • Available till sold out • Disponible jusqu'à épuisement du stock • Solange vorrat reicht

Tubi con ispezione Plus 1,2 mm

porcellanati in nero opaco

Plus matt black vitreous
enamelled pipes with inspection

Tubes émaillés Plus
en noir mat avec trappe de visite

Mattschwarz emailierte Plus
Rohre und Reinigungsöffnung

		L 100m		L 50cm		L 33cm	
Øcm	color	cod.	Pack	cod.	Pack	cod.	Pack
12,5	N	NNO125008	1	NNO125018	1	NNO125028*	1
15	N	NNO15008	1	NNO15018	1	NNO15028*	1
18	N	NNO18008	1	NNO18018	1	NNO18028*	1



L 100m



Disponibile fino ad esaurimento scorte • Available till sold out • Disponible jusqu'à épuisement du stock • Solange vorrat reicht

Gomiti Plus 1,2 mm

porcellanati in nero opaco,
nero ultra matt e grigio

Plus matt black, ultra matt black and grey
vitreous enamelled 90°, 45°, 30° and 15° elbows

Coudes émaillés Plus 90°, 45°, 30° et 15°
en noir mat, noir ultra mat et gris

Mattschwarz, ultra mattschwarz und grau emailierte
Plus Knie mit 90°, 45°, 30°, 15°-Winkel

Øcm	color	90°		45°		30°		15°	
		cod.	Pack	cod.	Pack	cod.	Pack	cod.	Pack
10	N	NNO1003	4	NNO1004	4	-	-	-	-
12	N	NNO1203	4	NNO1204	4	-	-	-	-
12,5	N	NNO12503	4	NNO12504	4	NNO12543	4	NNO12544	4
	U	UU12503	4	UU12504	4	-	-	-	-
13	N	NNO1303	4	NNO1304	4	-	-	-	-
14	N	NNO1403	4	NNO1404	4	-	-	-	-
15	N	NNO1503	4	NNO1504	4	NNO1543	4	NNO1544	4
	U	UU1503	4	UU1504	4	-	-	-	-
	G	GGO1503*	1	GGO1504*	1	-	-	-	-
15,3	N	NNO15303	4	NNO15304	4	-	-	-	-
16	N	NNO1603	1	NNO1604	1	-	-	-	-
18	N	NNO1803	1	NNO1804	1	-	-	-	-
	G	GGO1803*	1	GGO1804*	1	-	-	-	-
20	N	NNO2003	1	NNO2004	1	-	-	-	-



Disponibile fino ad esaurimento scorte • Available till sold out • Disponible jusqu'à épuisement du stock • Solange vorrat reicht

Gomiti con ispezione

Plus 1,2 mm

porcellanati in nero opaco,
nero ultra matt e grigio

Plus matt black, ultra matt black and grey vitreous enamelled
90° with inspection and 45° with inspection elbows

Coudes émaillés Plus 90° avec trappe de visite et 45°
avec trappe de visite en noir mat, noir ultra mat et gris

Mattschwarz, ultra mattschwarz und grau emailierte
Plus Knie mit 90°- und 45°-Winkel und Reinigungsöffnung

		90°		45°	
Øcm	color	cod.	Pack	cod.	Pack
10	N	NNO1008*	1	NNO10048*	1
12	N	NNO1208	1	-	-
12,5	N	NNO12508	1	NNO125048	1
13	N	NNO1308	1	-	-
15	N	NNO1508	1	NNO15048	1
	U	UU1508	1	-	-
	G	GGO1508*	1	-	-
15,3	N	NNO15308	1	-	-
16	N	NNO1608*	1	-	-
18	N	NNO1808	1	NNO18048*	1



Disponibile fino ad esaurimento scorte • Available till sold out • Disponible jusqu'à épuisement du stock • Solange vorrat reicht

Tubi per disassamento

Plus 1,2 mm

porcellanati in nero opaco

Plus matt black vitreous
enamelled offset pipes

Tubes émaillés Plus
en noir mat décalés

Mattschwarz emailierte
Plus Offset-Rohre

Øcm	color	cod.	Pack
12,5	N	NNO125OFF	1
15	N	NNO15OFF	1



Tubi a "T" Plus 1,2 mm

porcellanati in nero opaco,
nero ultra matt e grigio

Plus matt black, ultra matt black and grey vitreous enamelled
female-female or male-female T-pieces

Tés émaillés Plus femelle-femelle ou mâle-femelle
en noir mat, noir ultra mat et gris

Mattschwarz, ultra mattschwarz und grau emailierte Plus
T-Stücke Innengewinde/Innengewinde
oder Außengewinde/Innengewinde

		F/F		M/F	
Øcm	color	cod.	Pack	cod.	Pack
12	N	NNO1205F	1	-	-
12,5	N	NNO12505F	1	NNO12505M	1
	U	UU12505F	1	UU12505M	1
13	N	NNO1305F	1	-	-
14	N	NNO1405F	1	-	-
15	N	NNO1505F	1	NNO1505M	1
	U	UU1505F	1	UU1505M	1
	G	GGO1505F *	1	-	-
15,3	N	NNO15305F	1	-	-
18	N	NNO1805F	1	NNO1805M *	1
	G	GGO1805F *	1	-	-
20	N	NNO2005F	1	-	-

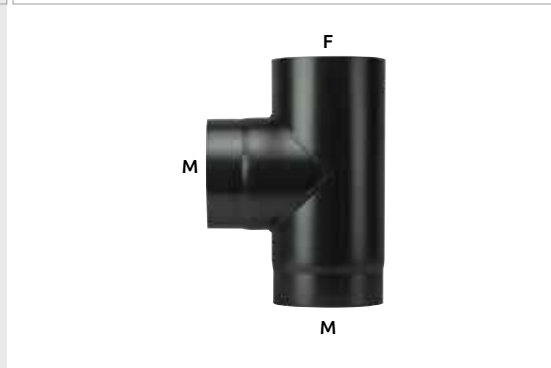

* Disponibile fino ad esaurimento scorte • Available till sold out • Disponible jusqu'à épuisement du stock • Solange vorrat reicht

Tappi ciechi per tubi a "T" Plus 1,2 mm

porcellanati in nero opaco,
nero ultra matt e grigio

Plus matt black, ultra matt black and grey vitreous
enamelled Blind covers for plus 1.2mm T-pieces
Tampons borgnes pour tés plus 1,2mm émaillés
en noir mat, noir ultra mat et gris

Mattschwarz, ultra mattschwarz und grau emailierte
Blindstopfen für T-Stücke plus 1,2mm

Øcm	color	cod.	Pack
12	N	NNO1219C	1
12,5	N	NNO12519C	1
	U	UU12519C	1
13	N	NNO1319C	1
14	N	NNO1419C	1
15	N	NNO1519C	1
	U	UU1519C	1
	G	GGO1519C*	1
15,3	N	NNO15319C	1
18	N	NNO1819C	1
	G	GGO1819*	1
20	N	NNO2019C	1



Disponibile fino ad esaurimento scorte • Available till sold out • Disponible jusqu'à épuisement du stock • Solange vorrat reicht

Tubi con serranda H 25cm Plus 1,2 mm

porcellanati in nero opaco

Plus matt black and vitreous enamelled
pipes with flue damper h. 25 cm

Tubes émaillés Plus en noir mat
avec registre h 25 cm

Mattschwarz emailierte Plus
Rohre mit Schieber, h 25 cm

Øcm	color	cod.	Pack
10	N	NNO1006*	1
12	N	NNO1206	1
12,5	N	NNO12506	1
13	N	NNO1306	1
14	N	NNO1406*	1
15	N	NNO1506	1
15,3	N	NNO15306*	1
16	N	NNO1606*	1
18	N	NNO1806	1
20	N	NNO2006*	1



Disponibile fino ad esaurimento scorte • Available till sold out • Disponible jusqu'à épuisement du stock • Solange vorrat reicht

Raccordi Plus 1,2 mm

porcellanati in nero opaco,
nero ultra matt e grigio

Plus matt black, ultra matt black and grey vitreous enamelled
female-female or male-male fittings h. 12cm

Raccords émaillés Plus femelle-femelle ou mâle-mâle
h 12cm en noir mat, noir ultra mat et gris

Mattschwarz, ultra mattschwarz und grau emailierte Plus
Anschlussstücke Innengewinde/Innengewinde
oder Außengewinde/Außengewinde (h12 cm)

		F/F		M/M	
Øcm	color	cod.	Pack	cod.	Pack
10	N	NNO1017F*	2	NNO1017M*	2
12	N	NNO1217F	2	NNO1217M*	2
12,5	N	NNO12517F	2	NNO12517M	2
	U	UU12517F	2	UU12517M	2
13	N	NNO1317F	2	NNO1317M*	2
14	N	NNO1417F*	2	NNO1417M*	2
15	N	NNO1517F	2	NNO1517M	2
	U	UU1517F	2	UU1517M	2
	G	GGO1517F*	2	GGO1517M*	2
15,3	N	NNO15317F*	2	NNO15317M*	2
16	N	NNO1617F*	2	-	-
18	N	NNO1817F	2	NNO1817M*	2
	G	GGO1817F*	2	GGO1817M*	2
20	N	NNO2017F*	2	NNO2017M*	2



* Disponibile fino ad esaurimento scorte • Available till sold out • Disponible jusqu'à épuisement du stock • Solange vorrat reicht

LINEA WOOD

Plus LIGHT



Tubi per stufe a legna porcellanati
Vitreous enamelled pipes for wood stove
Tubes émaillé pour poêles à bois
Emaillierte Rohre für Holzofen



DoP N°6 - Plus Light
www.savefumisteria.it > Download

GAMMA COLORI COLOR RANGE

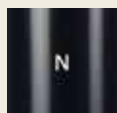

Nero opaco
Matt black
Noir mat
Mattschwarz

CARATTERISTICHE FEATURES

Questi tubi sono più leggeri ed economici rispetto alla linea Plus 1,2mm, pur mantenendo tutte le caratteristiche normative e prestazionali. Sono perfettamente compatibili sia dal punto di vista tecnico per imbocchi e dimensioni, sia dal punto di vista estetico per l'uguale finitura in smalto porcellanato. Su questi tubi si possono utilizzare gomiti e T della linea Plus 1,2mm oppure gomiti della linea Classic.

Rappresentano il massimo qualitativo della produzione SAVE Spa: tubi in acciaio al carbonio saldati a laser per ottenere saldature perfette, vengono successivamente ricoperti internamente ed esternamente con smalto vetroporcellanato cotto a temperatura di 850°C per conferire eccezionali qualità di resistenza alla corrosione delle condense di combustione.

I risultati del test V2 previsto dalla norma 1856-2 sulla resistenza alla corrosione, hanno dimostrato che i canali da fumo Plus 1.2mm e Plus Light hanno una durata decisamente superiore ai normali tubi verniciati di sp. 2mm non vetrificati internamente.

Resistono perfettamente anche a situazioni estreme come il fuoco di fuliggine (incendio che avviene dentro il tubo) senza rovinarsi o alterarsi.

La Dichiarazione di Prestazioni (DoP) n°6 Plus Light è disponibile sul sito www.savefumisteria.it alla pagina "download", con tutti i riferimenti ai test eseguiti e le istruzioni di montaggio e manutenzione a garanzia di assoluta sicurezza nell'utilizzo.

SUL NOSTRO SITO www.savefumisteria.it SONO DISPONIBILI INFORMAZIONI PIÙ DETTAGLIATE SU OGNI SINGOLO PRODOTTO.

These pipes are lighter and less expensive than the Plus 1.2mm line, while maintaining all the characteristics and performance standards. They are fully compatible from both the technical point of view - thanks to the same connections and dimensions - and the aesthetical point of view, thanks to the same enamel coating. These pipes can be fitted with Plus 1.2 mm line elbows and tees or Classic line elbows.

Representing the highest level of SAVE Spa quality, laser-welding ensures these carbon steel pipes perfect welding. Subsequent internal/external vitreous enamel coating baked to 850°C provides exceptional resistance against corrosion by combustion condensate.

V2 test results specified by corrosion resistance Standard 1856-2 show that Plus 1.2 mm and Plus Light flue pipes have a significantly longer duration than normally painted 2 mm thick pipes that have not received internal vitreous enamel coating.

They are perfectly resistant even to extreme situations such as soot-fire (a fire that occurs inside the pipe) without being damaged or modified.

The Declaration of Performance (DoP) n°6 Plus Light is available at www.savefumisteria.it in the download area, with reference to all the tests performed and Installation and Maintenance Instructions to ensure the greatest safety during use.

MORE DETAILED INFORMATION ABOUT EACH PRODUCTS ARE AVAILABLE ON OUR WEBSITE www.savefumisteria.it

ANTICONDENSA ANTI-CONDENSATE

Per evitare la fuoriuscita di condensa è necessario che vengano montati con l'imbocco rivolto verso il basso (vedi disegno). Per fare questo può essere necessario usare come partenza il raccordo F/F anticondensa.

In order to prevent the leakage of condensate, they must be fitted with the inlet facing downwards (see drawing). To do this, it may be necessary to use an F/F anti-condensate fitting to start with.

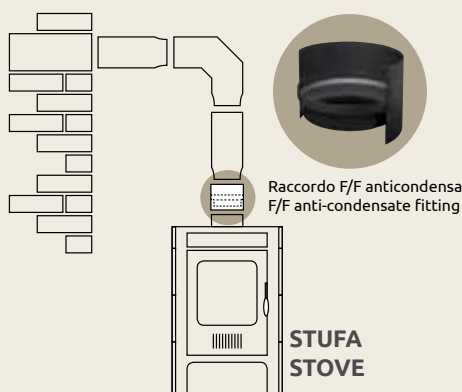

DESIGNAZIONI DESIGNATION

- Ⓒ EN 1856-2 – T600 – N1 – W – V2 – L80070 – G600NM
- Ⓒ EN 1856-2 – T600 – N1 – W – V2 – L80070 – O600
- Ⓒ EN 1856-2 – T450 – N1 – W – V2 – L80070 – G600NM
- Ⓒ EN 1856-2 – T450 – N1 – W – V2 – L80070 – O450

Tubi Plus **LIGHT**

porcellanati in nero opaco

Plus Light matt black vitreous enamelled pipes

Tubes émaillés Plus Light en noir mat

Mattschwarz emailierte Plus Rohre

Øcm	color	L 100cm		L 50cm		L 25cm	
		cod.	Pack	cod.	Pack	cod.	Pack
12	N	NNOL1200	6	NNOL1201	6	NNOL1202	6
12,5	N	NNOL12500	6	NNOL12501	6	NNOL12502	6
13	N	NNOL1300	6	NNOL1301	6	NNOL1302	6
14	N	NNOL1400	6	NNOL1401	6	NNOL1402	6
15	N	NNOL1500	6	NNOL1501	6	NNOL1502	6
15,3	N	NNOL15300	6	NNOL15301	6	NNOL15302	6



Tubi telescopici H50cm e H33cm Plus **LIGHT**

porcellanati in nero opaco

Plus Light matt black vitreous enamelled telescopic pipes h. 50 cm and h. 33 cm

Tubes émaillés télescopiques Plus h 50 cm et h 33 cm en noir mat

Ausziehbare emailierte Plus Rohre (h 50 cm und h 33 cm) in mattschwarz

Øcm	color	H 50cm		H 33cm	
		cod.	Pack	cod.	Pack
12,5	N	NNOL12521*	1	NNOL12520*	1
15	N	NNOL1521*	1	NNOL1520*	1
15,3	N	NNOL15321*	1	NNOL15320*	1



Disponibile fino ad esaurimento scorte • Available till sold out • Disponible jusqu'à épuisement du stock • Solange vorrat reicht

Gomiti Plus 1,2 mm

porcellanati in nero opaco

Plus matt black vitreous enamelled
90°, 45°, 30° and 15° elbows

Coudes émaillés Plus
90°, 45°, 30° et 15° en noir mat

Mattschwarz emailierte Plus Knie
mit 90°-, 45°-, 30°-, 15°-Winkel

100% compatible with

Plus **LIGHT**

		90°		45°		30°		15°	
Øcm	color	cod.	Pack	cod.	Pack	cod.	Pack	cod.	Pack
12	N	NNO1203	4	NNO1204	4	-	-	-	-
12,5	N	NNO12503	4	NNO12504	4	NNO12543	4	NNO12544	4
13	N	NNO1303	4	NNO1304	4	-	-	-	-
14	N	NNO1403	4	NNO1404	4	-	-	-	-
15	N	NNO1503	4	NNO1504	4	NNO1543	4	NNO1544	4
15,3	N	NNO15303	4	NNO15304	4	-	-	-	-



Gomiti con ispezione Plus 1,2 mm

porcellanati in nero opaco

Plus matt black vitreous enamelled
90° with inspection and 45° with
inspection elbows

Coudes émaillés Plus
90° avec trappe de visite et
45° avec trappe de visite en noir mat

Mattschwarz emailierte Plus Knie
mit 90°- und 45° -Winkel und Reinigungsöffnung

100% compatible with

Plus **LIGHT**

		90°		45°	
Øcm	color	cod.	Pack	cod.	Pack
12	N	NNO1208	1	-	-
12,5	N	NNO12508	1	NNO125048	1
13	N	NNO1308	1	-	-
15	N	NNO1508	1	NNO15048	1
15,3	N	NNO15308	1	-	-



Tubi a "T" Plus 1,2 mm

porcellanati in nero opaco

Plus matt black vitreous enamelled
female-female or male-female T-pieces

Tés émaillés Plus femelle-femelle
ou mâle-femelle en noir mat

Mattschwarz emailierte Plus
T-Stücke Innengewinde/Innengewinde
oder Außengewinde/Innengewinde

100% compatible with

Plus LIGHT

F/F				M/F	
Øcm	color	cod.	Pack	cod.	Pack
12	N	NNO1205F	1	-	-
12,5	N	NNO12505F	1	NNO12505M	1
13	N	NNO1305F	1	-	-
14	N	NNO1405F	1	-	-
15	N	NNO1505F	1	NNO1505M	1
15,3	N	NNO15305F	1	-	-

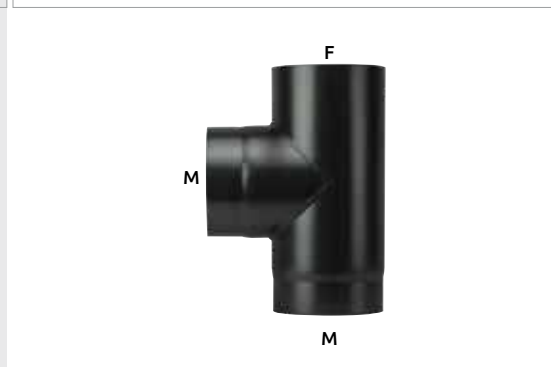

Tappi ciechi per tubi a "T" Plus 1,2 mm

porcellanati in nero opaco

Plus matt black vitreous enamelled
Blind covers for Plus 1.2mm T-pieces

Tampons borgnes pour tés Plus 1,2mm
émaillés en noir mat

Mattschwarz emailierte Blindstopfen
für T-Stücke Plus 1,2mm

100% compatible with

Plus LIGHT

Øcm	color	cod.	Pack
12	N	NNO1219C	1
12,5	N	NNO12519C	1
13	N	NNO1319C	1
14	N	NNO1419C	1
15	N	NNO1519C	1
15,3	N	NNO15319C	1



Tubi con serranda

H 25cm Plus 1,2 mm

porcellanati in nero opaco

Plus matt black and vitreous enamelled
pipes with flue damper h. 25 cm

Tubes émaillés Plus en noir mat
avec registre h 25 cm

Mattschwarz emaillierte Plus
Rohre mit Schieber, h 25 cm

100% compatible with

Plus LIGHT

Øcm	color	cod.	Pack
12	N	NNO1206	1
12,5	N	NNO12506	1
13	N	NNO1306	1
14	N	NNO1406*	1
15	N	NNO1506	1
15,3	N	NNO15306*	1



Disponibile fino ad esaurimento scorte • Available till sold out • Disponible jusqu'à épuisement du stock • Solange vorrat reicht

Raccordi

Plus 1,2 mm

porcellanati in nero opaco

Plus matt black vitreous enamelled
female-female or male-male fittings h.12cm

Raccords émaillés Plus femelle-femelle
ou mâle-mâle h 12cm en noir mat

Mattschwarz emaillierte Plus
Anschlussstücke Innengewinde/Innengewinde
oder Außengewinde/Außengewinde (h12 cm)

100% compatible with

Plus LIGHT

Øcm	color	F/F		M/M	
		cod.	Pack	cod.	Pack
12	N	NNO1217F	2	NNO1217M*	2
12,5	N	NNO12517F	2	NNO12517M	2
13	N	NNO1317F	2	NNO1317M*	2
14	N	NNO1417F*	2	NNO1417M*	2
15	N	NNO1517F	2	NNO1517M	2
15,3	N	NNO15317F*	2	NNO15317M*	2



Disponibile fino ad esaurimento scorte • Available till sold out • Disponible jusqu'à épuisement du stock • Solange vorrat reicht

LINEA WOOD

Accessori Plus & Plus **LIGHT**

Accessori "PLUS & PLUS LIGHT" in nero opaco, nero ultra matt e grigio
Matt black, ultra matt black and grey "PELLET" accessories
Accessoires "PELLET" en noir mat, noir ultra mat et gris
Accessoires Baureihe "PELLET" in mattschwarz, ultra mattschwarz und grau

GAMMA COLORI COLOR RANGE

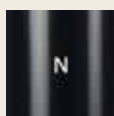

N
Nero opaco
Matt black
Noir mat
Mattschwarz



U
Nero ultra matt
Ultramatt black
Noir ultramat
Schwarz ultramatt



G
Grigio
Grey
Gris
Grau

ATTENZIONE:

Tutti gli accessori verniciati sono compatibili con le finiture smaltate nero opaco e nero ultra matt.

ATTENTION:

All black painted accessories are compatible with vitreous enamelled finishes in matt black and ultra matt black.

AVERTISSEMENT:

Tous les accessoires en peinture noir sont compatibles avec les finitions en emaille noir matt et noir ultra matt.

ACHTUNG:

Alle schwarz lackierte Zubehöre sind kompatibel mit emallierte Rohre in mattschwarz und ultra mattschwarz.

CARATTERISTICHE FEATURES

Tutti gli Accessori Plus SAVE sono appositamente studiati per essere perfettamente adattabili alle linee Pellet, Pellet Light, Plus 1,2mm, Plus Light.

All the Plus SAVE accessories have been specifically designed to fit the Pellet, Pellet Light, Plus 1,2mm, Plus Light.

SUL NOSTRO SITO www.savefumisteria.it SONO DISPONIBILI INFORMAZIONI PIÙ DETTAGLIATE SU OGNI SINGOLO PRODOTTO.

MORE DETAILED INFORMATION ABOUT EACH PRODUCTS ARE AVAILABLE ON OUR WEBSITE www.savefumisteria.it

Pellet

Pellet

Pellet
LIGHT

Accessori
Pellet

Wood

Plus
1,2mm

Plus
LIGHT

Accessori
Plus

Plus & Plus Light

Anelli Plus

verniciati in nero opaco e grigio

Matt black and grey painted Plus ring

Anneaux Plus laqués noir mat e gris

Mattschwarz und grau lackierte Plus Ringe

90°				45°	
Øcm	color	cod.	Pack	cod.	Pack
10	N	NN1010	10	-	-
12	N	NN1210	10	-	-
12,5	N	NN12510	10	NN12514	10
13	N	NN1310	10	-	-
14	N	NN1410	10	-	-
15 / 15,3	N	NN1510	10	NN1514	10
	G	GG1510 *	10	-	-
16	N	NN1610	10	-	-
18	N	NN1810	10	-	-
	G	GG1810 *	10	-	-
20	N	NN2010	10	-	-



* Disponibile fino ad esaurimento scorte • Available till sold out • Disponible jusqu'à épuisement du stock • Solange vorrat reicht

Plus & Plus Light

Kit fissaggio magnetico per anelli

Magnetic fixing kit for rings

Magnetic kit de montage pour les anneaux

Magnetischer Montage-Kit für Ringe

cod.	Pack
NNFIX	20



Plus & Plus Light

Rosoni Plus

verniciati in nero opaco e grigio

Matt black and grey painted Plus covers

Rosaces Plus laqués noir mat e gris

Mattschwarz und grau lackierte Plus Rosetten

Øcm	color	cod.	Pack
12	N	NN1209	5
13	N	NN1309	5
14	N	NN1409	5
15	N	NN1509	5
	G	GG1509 *	5
16	N	NN1609 *	5
18	N	NN1809 *	5
20	N	NN2009 *	5



Disponibile fino ad esaurimento scorte • Available till sold out • Disponible jusqu'à épuisement du stock • Solange vorrat reicht

Plus & Plus Light

Reggitubo Plus

verniciati in nero opaco e grigio

Matt black and grey painted stainless steel Plus pipe holder

Porte-tubes Plus laqué noir mat et gris

Mattschwarz und grau lackierter Plus Rohhalter mit Dübel

Øcm	color	cod.	Pack
10	N	NN210	10
12	N	NN212	10
13 / 12,5	N	NN213	10
14	N	NN214	10
15 / 15,3	N	NN215	10
	G	GG215 *	10
16	N	NN216	10
18	N	NN218	10
	G	GG218 *	10
20	N	NN220	10



Disponibile fino ad esaurimento scorte • Available till sold out • Disponible jusqu'à épuisement du stock • Solange vorrat reicht

Plus & Plus Light

Riduzioni Plus

porcellanate in nero opaco e grigio

Matt black and grey vitreous enamelled Plus reducers

Réductions Plus émaillés noir mat et gris

Mattschwarz und grau emailierte Plus Reduzierstücke

Øcm	color	cod.	Pack
20F / 18M	N	NNO20F/18M	2
20F / 15M	N	NNO20F/15M	2
18F / 15M	N	NNO18F/15M	2
	G	GGO18F/15M*	2
16F / 15M	N	NNO16F/15M	2
15,3F / 15M	N	NNO153F/15M	2
15F / 14M	N	NNO15F/14M	2
	G	GGO15F/14M*	2
15F / 13M	N	NNO15F/13M	2
15F / 12,5M	N	NNO15F/125M	2
15F / 12M	N	NNO15F/12M	2
14F / 13M	N	NNO14F/13M	2
14F / 12M	N	NNO14F/12M*	2
13F / 12M	N	NNO13F/12M	2
12,5F / 13M	N	NNO125F/13M*	2



* Disponibile fino ad esaurimento scorte • Available till sold out • Disponible jusqu'à épuisement du stock • Solange vorrat reicht

Plus & Plus Light

Raccordi telescopici a soffitto Plus

verniciati in nero opaco

Plus matt black painted
telescopic ceiling fittingsRaccords télescopiques Plus
plafond laqués noir matAusziehbares Plus
Deckenanschlussstück,
mattschwarz lackiert

Øcm	color	cod.	Pack
15	N	NN1511	1



Plus & Plus Light

Raccordi F/F anticondensa Plus

porcellanati in nero opaco,
nero ultra matt e grigio

Matt black, ultra matt black and grey vitreous enamelled Plus
female-female anti-condensate fittings

Raccords anticondensation Plus femelle-femelle émaillés
en noir mat, noir ultra mat et gris

Anschlussstücke mit Kondensationsschutz Plus,
Innengewinde/Innengewinde, mattschwarz,
ultra mattschwarz und grau emaillierte

Øcm	color	cod.	Pack
12	N	NNO1231	2
12,5	N	NNO12531	2
	U	UU12531	2
13	N	NNO1331	2
14	N	NNO1431	2
15	N	NNO1531	2
	U	UU1531	2
15,3	N	NNO15331	2
18	N	NNO1831	2
	G	GGO1831*	2
20	N	NNO2031	2



Disponibile fino ad esaurimento scorte • Available till sold out • Disponible jusqu'à épuisement du stock • Solange vorrat reicht

Plus & Plus Light

Serrande Plus

verniciate in nero opaco e grigio

Plus matt black and grey painted flue damper

Registre Plus laqué noir mat et gris

Plus Schieber, mattschwarz und grau lackiert

Øcm	color	cod.	Pack
12-13	N	NN12/1315	1
14-15-16	N	NN14/15/1615	1
	G	GG14/15/1615*	1
18-20	N	NN18/2015	1
	G	GG18/2015*	1



Disponibile fino ad esaurimento scorte • Available till sold out • Disponible jusqu'à épuisement du stock • Solange vorrat reicht





Pedane

in acciaio verniciato nero opaco
e vetro temperato

Matt black painted steel
and toughened glass bases

Bases en acier laqué noir mat
et verre trempé

Bodenplatten aus mattschwarz
lackiertem Stahl und Sekuritglas

	100x90cm		90x80cm		80x60cm		70x60cm		
color	cod.	Pack	cod.	Pack	cod.	Pack	cod.	Pack	
N	P100/90 *	1	P90/80	1	P80/60	1	P70/60 *	1	
	-	-	-	-	PV80/60 *	1	-	-	
									



Disponibile fino ad esaurimento scorte • Available till sold out • Disponible jusqu'à épuisement du stock • Solange vorrat reicht

Bombolette spray per ritocchi

colore nero opaco e grigio

Spray canisters for touch-ups
(matt black and grey)

Vaporisateurs pour retouches
(noir mat et gris)

Spraydosen zum Nachbessern
(mattschwarz und grau)

color	cod.	Pack
N	NNSPRAY	1
G	GGSPRAY *	1



Disponibile fino ad esaurimento scorte • Available till sold out • Disponible jusqu'à épuisement du stock • Solange vorrat reicht

Coppelle di coibentazione

in lana di roccia spessore 30mm

30 mm thick rock wool
pipe insulators

Couppelles d'isolement en laine
de roche épaisseur 30 mm

Dämmmantel - Steinwolle,
Stärke 30 mm

Øcm	cod.	Pack
8	AA815	10
10	AA1015	8
12	AA1215	7
13	AA1315	7
14	AA1415 *	7
15	AA1515	7



Disponibile fino ad esaurimento scorte • Available till sold out • Disponible jusqu'à épuisement du stock • Solange vorrat reicht

LINEA WOOD

Classic

Tubi porcellanati Classic in bianco, marrone e nero opaco
Classic white, brown and matt black vitreous enamelled pipes
Tubes émaillés Classic en blanc, marron et noir mat
Weiß, braun und mattschwarz emaillierte Classic Rohre



DoP N°1 - Classic

1www.savefumisteria.it > Download

GAMMA COLORI COLOR RANGE



Bianco
White
Blanc
Weiss



Marrone
Brown
Marron
Braun

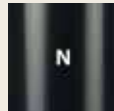

Nero opaco
Matt black
Noir mat
Mattschwarz

CARATTERISTICHE FEATURES

I tubi smaltati SAVE sono prodotti con lamiera di acciaio rivestita con smalto porcellanato tramite un procedimento che prevede la cottura del pezzo a ben 830°C.

Lo smalto porcellanato rende questo tubo preferibile ad ogni altro per alcune caratteristiche:

- resistenza alle più alte temperature di esercizio: T600, la classe più alta secondo la EN 1856-2
- resistenza allo sbalzo termico
- resistenza alla corrosione da condensa certificata dal superamento del test V2 che li rende idonei all'utilizzo con qualsiasi tipo di combustibile: solido, liquido e gassoso
- resistenza all'abrasione e agli agenti chimici: sono lavabili con qualsiasi solvente o prodotto per la pulizia.
- tenuta ai gas della combustione (tiraggio naturale)
- qualità estetica: i colori non si alterano con l'uso o con le alte temperature

La Dichiarazione di Prestazioni (DoP) n°1 Classic è disponibile sul sito www.savefumisteria.it alla pagina "download", con tutti i riferimenti ai test eseguiti e le istruzioni di montaggio e manutenzione a garanzia di assoluta sicurezza nell'utilizzo.

SUL NOSTRO SITO www.savefumisteria.it SONO DISPONIBILI INFORMAZIONI PIÙ DETTAGLIATE SU OGNI SINGOLO PRODOTTO.

The SAVE vitreous enamelled pipes are made of sheet steel coated with vitreous enamel and baked at 830°C.

The vitreous enamel coating makes this pipe better than any other pipe thanks to some of its features:

- resistance to the highest working temperatures: T600, the highest class according to EN 1856-2
- resistance to any changes in temperature
- resistance to condensate corrosion certified by the outcome of the V2 test for qualification for use with any type of solid, liquid or gas fuel.
- resistance to abrasion and chemical agents; they can be cleaned with any solvent or cleaning product
- combustion gas-tight (natural draught)
- aesthetic quality: colours do not alter with use or as a result of high temperatures

The Declaration of Performance (DoP) n°1 Classic is available at www.savefumisteria.it in the download area, with reference to all the tests performed and Installation and Maintenance Instructions to ensure the greatest safety during use.

MORE DETAILED INFORMATION ABOUT EACH PRODUCTS ARE AVAILABLE ON OUR WEBSITE www.savefumisteria.it

CAMPO DI APPLICAZIONE FIELD OF APPLICATION

APPARECCHI E STUFE A:

- Legna
- Carbone
- Gas
- Gasolio
- Kerosene

APPLIANCES AND STOVES:

- Wood-burning
- Coal
- Gas
- Gas oil
- Kerosene

DESIGNAZIONI DESIGNATION

⊕ EN 1856-2 – T600 – N1 – D – V2 – L80055 – G450NM

⊕ EN 1856-2 – T600 – N1 – D – V2 – L80055 – O450

⊕ EN 1856-2 – T450 – N1 – D – V2 – L80055 – G450NM

⊕ EN 1856-2 – T450 – N1 – D – V2 – L80055 – O350

Pellet

Pellet

Pellet
LIGHT

Accessori
Pellet

Wood

Plus
1,2mm

Plus
LIGHT

Accessori
Plus

Classic

Tubi Classic

porcellanati in bianco,
marrone e nero opaco

Classic white, brown and matt black
vitreous enamelled pipes

Tubes émaillés Classic
en blanc, marron et noir mat

Weiß, braun und Mattschwarz
emailierte Classic Rohre

Øcm	color	L 100cm		L 50cm		L 25cm	
		cod.	Pack	cod.	Pack	cod.	Pack
8	B	B800	12	B801	12	B802	12
	M	M800	12	M801	12	M802	12
9	B	B900	12	B901	12	B902	12
10	B	B1000	12	B1001	12	B1002	12
	M	M1000	12	M1001	12	M1002	12
	N	NO1000	12	NO1001	12	NO1002	12
11	B	-	-	B1101*	12	B1102*	12
	M	M1100*	12	M1101*	12	M1102*	12
12	B	B1200	12	B1201	12	B1202	12
	M	M1200	12	M1201	12	M1202	12
	N	NO1200	12	NO1201	12	NO1202	12
13	B	B1300	12	B1301	12	B1302	12
	M	M1300	12	M1301	12	M1302	12
	N	NO1300	12	NO1301	12	NO1302	12
14	B	B1400	6	B1401	6	B1402	6
	M	M1400	6	M1401	6	M1402	6
	N	NO1400	6	NO1401	6	NO1402	6
15	B	B1500	6	B1501	6	B1502	6
	M	M1500	6	M1501	6	M1502	6
	N	NO1500	6	NO1501	6	NO1502	6



* Disponibile fino ad esaurimento scorte • Available till sold out • Disponible jusqu'à épuisement du stock • Solange vorrat reicht



Gomiti Classic

porcellanati in bianco,
marrone e nero opaco

Classic white, brown and matt black
vitreous enamelled 90° and 45° elbows

Coudes émaillés Classic 90° et 45°
en blanc, marron et noir mat

Weiß, braun und Mattschwarz
emailierte Classic 90°- und 45°-Knie

Øcm	color	90°		45°	
		cod.	Pack	cod.	Pack
8	B	B803	12	B804	12
	M	M803	12	M804	12
9	B	B903	12	-	-
10	B	B1003	12	B1004	12
	M	M1003	12	M1004	12
	N	NO1003	12	NO1004	12
11	M	M1103*	12	-	-
12	B	B1203	12	B1204	12
	M	M1203	12	M1204	12
	N	NO1203	12	NO1204	12
13	B	B1303	12	B1304	12
	M	M1303	12	M1304	12
	N	NO1303	12	NO1304	12
14	B	B1403	6	B1404	6
	M	M1403	6	M1404	6
	N	NO1403	6	NO1404	6
15	B	B1503	6	B1504	6
	M	M1503	6	M1504	6
	N	NO1503	6	NO1504	6



Disponibile fino ad esaurimento scorte • Available till sold out • Disponible jusqu'à épuisement du stock • Solange vorrat reicht



Tubi H 25cm con foro per serranda Classic

porcellanati in bianco,
marrone e nero opaco

Classic white, brown and matt black vitreous enamelled drilled pipes for flue dampers (h= 25 cm)

Tubes Classic ayant un trou pour le registre (h=25 cm) en blanc, marron et noir mat

Emaillierte Classic Rohre mit Öffnung für Schieber (H=25 cm) in weiß, braun und mattschwarz

Øcm	color	cod.	Pack
10	B	B1006*	12
12	B	B1206*	12
	M	M1206	12
	N	NO1206*	12



* Disponibile fino ad esaurimento scorte • Available till sold out • Disponible jusqu'à épuisement du stock • Solange vorrat reicht

Diffusori di calore a 8 canne Classic

porcellanati in bianco,
marrone e nero opaco

Classic white, brown and matt black vitreous enamelled 8-pipe heaters

Diffuseurs de chaleur Classic à 8 canneaux émaillés en blanc, marron et noir mat

Heizelemente mit 8 emaillierten Classic Rohren in weiß, braun und mattschwarz

Øcm	color	cod.	Pack
10	B	B1007*	3
	M	M1007*	3
	N	NO1007*	3
12	B	B1207	3
	M	M1207	3
	N	NO1207	3



* Disponibile fino ad esaurimento scorte • Available till sold out • Disponible jusqu'à épuisement du stock • Solange vorrat reicht

Tubi ad "H" Classic

porcellanati in marrone

Classic brown vitreous enamelled H-pieces

Tubes émaillés Classic en forme de H, en marron

Braun emaillierte H-förmige Classic Rohre

Øcm	color	cod.	Pack
12	M	M1208	5



Rosoni Master Euroflues

verniciati in bianco, marrone,
nero e alluminati

Euroflues Master covers painted in white,
brown, black and aluminized steel

Rosaces Master Euroflues laquées blanc,
marron, noir et en acier aluminatée

Weiß, braun, Schwarz lackierte und
Aluminatstahl Master Euroflues Rosetten

Øcm	color	cod.	Pack
8	B	EB809	10
	M	EM809	10
	N	EN809	10
	A	EA809	10
9	B	EB909	10
	A	EA909	10
10	B	EB1009	10
	M	EM1009	10
	N	EN1009	10
	A	EA1009	10
11	B	EB1109	10
	A	EA1109	10
12	B	EB1209	10
	M	EM1209	10
	N	EN1209	10
	A	EA1209	10
13	B	EB1309	10
	M	EM1309	10
	N	EN1309	10
	A	EA1309	10
14	B	EB1409	10
	M	EM1409	10
	N	EN1409	10
	A	EA1409	10
15	B	EB1509	10
	M	EM1509	10
	N	EN1509	10
	A	EA1509	10
16	B	EB1609	10
	A	EA1609	10
18	B	EB1809	10
	A	EA1809	10
20	B	EB2009	10
	A	EA2009	10



Riduzioni Master Euroflues

verniciate in bianco, marrone,
nero opaco e alluminio

Euroflues Master white, brown, matt black
painted and aluminium reducers

Réductions Master Euroflues laquées blanc,
marron, noir mat et en aluminium

Weiß, braun, mattschwarz lackierte und
Aluminium Master Euroflues reduzierstücke

Øcm	color	cod.	Pack
9F / 8M	B	EB9F/8M	10
	M	EM9F/8M	10
10F / 8M	B	EB10F/8M	10
	M	EM10F/8M	10
	N	ENO10F/8M	10
10F / 9M	B	EB10F/9M	10
11F / 8M	B	EB11F/8M*	10
	M	EM11F/8M*	10
11F / 9M	B	EB11F/9M	10
11F / 10M	B	EB11F/10M	10
	M	EM11F/10M	10
12F / 8M	B	EB12F/8M	10
	M	EM12F/8M	10
	N	ENO12F/8M	10
	A	EA12F/8M*	10
12F / 9M	B	EB12F/9M	10
	M	EM12F/9M*	10
	A	EA12F/9M*	10
12F / 10M	B	EB12F/10M	10
	M	EM12F/10M	10
	N	ENO12F/10M	10
	A	EA12F/10M	10
12F / 11M	B	EB12F/11M	10
	M	EM12F/11M	10
	N	ENO12F/11M*	10
	A	EA12F/11M*	10
13F / 8M	B	EB13F/8M	10
	A	EA13F/8M*	10
13F / 9M	B	EB13F/9M*	10
13F / 10M	B	EB13F/10M	10
	M	EM13F/10M	10
	N	ENO13F/10M	10

Øcm	color	cod.	Pack
13F / 11M	B	EB13F/11M	10
	M	EM13F/11M*	10
13F / 12M	B	EB13F/12M	10
	M	EM13F/12M	10
	N	ENO13F/12M	10
	A	EA13F/12M	10
14F / 8M	B	EB14F/8M	10
14F / 10M	B	EB14F/10M	10
	M	EM14F/10M*	10
	N	ENO14F/10M*	10
	A	EA14F/10M*	10
14F / 11M	B	EB14F/11M	10
	M	EM14F/11M*	10
	A	EA14F/11M*	10
14F / 12M	B	EB14F/12M	10
	M	EM14F/12M	10
	N	ENO14F/12M	10
	A	EA14F/12M	10
14F / 13M	B	EB14F/13M	10
	M	EM14F/13M	10
	N	ENO14F/13M	10
	A	EA14F/13M*	10
15F / 12M	B	EB15F/12M	10
	M	EM15F/12M	10
	N	ENO15F/12M	10
	A	EA15F/12M	10
15F / 13M	B	EB15F/13M	10
	N	ENO15F/13M	10
	A	EA15F/13M	10
15F / 14M	B	EB15F/14M	10
	N	ENO15F/14M	10
	A	EA15F/14M	10

Øcm	color	cod.	Pack
16F / 14M	B	EB16F/14M*	10
	M	EM16F/14M*	10
	N	ENO16F/14M*	10
	A	EA16F/14M*	10
16F / 15M	B	EB16F/15M*	10
	M	EM16F/15M*	10
	N	ENO16F/15M*	10
18F / 15M	A	EA18F/15M*	10
18F / 16M	B	EB18F/16M*	10
	M	EM18F/16M*	10
	A	EA18F/16M*	10
20F / 18M	B	EB20F/18M*	10
	M	EM20F/18M*	10

Øcm	color	cod.	Pack
8F / 10M	B	EB8F/10M	10
	M	EM8F/10M	10
	N	ENO8F/10M	10
8F / 12M	B	EB8F/12M	10
	M	EM8F/12M	10
	N	ENO8F/12M	10
10F / 12M	B	EB10F/12M	10
	M	EM10F/12M	10
	N	ENO10F/12M	10
11F / 12M	B	EB11F/12M	10



Disponibile fino ad esaurimento scorte • Available till sold out • Disponible jusqu'à épuisement du stock • Solange vorrat reicht

Serrande

zincate

Galvanised flue dampers

Registres galvanisé

Verzinkte Schieber

Øcm	color	cod.	Pack
10	Z	Z1015*	1
11	Z	Z1115*	1
12	Z	Z1215	1
13	Z	Z1315*	1
16	Z	Z1615*	1



Disponibile fino ad esaurimento scorte • Available till sold out • Disponible jusqu'à épuisement du stock • Solange vorrat reicht

Reggitubo Classic

verniciati in bianco,
marrone e nero

Classic white, brown and black
painted pipe holder

Porte-tubes à cheville Classic
laqué blanc, marron et noir

Lackierter Classic Rohrhalter mit Dübel
in weiß, braun und schwarz

Øcm	color	cod.	Pack
8 / 13	N	N28/13*	5
10 / 15	B	B210/15	5
	M	M210/15	5
	N	N210/15*	5



Disponibile fino ad esaurimento scorte • Available till sold out • Disponible jusqu'à épuisement du stock • Solange vorrat reicht

Stendibiancheria Classic

verniciati in bianco
e marrone

Classic white and brown
clothes drier

Séchoir à linge Classic
en blanc et marron

Classic Wäschetrockner
in weiß und braun

Øcm	color	cod.	Pack
8 / 14	B	B5	6
	M	M5*	6

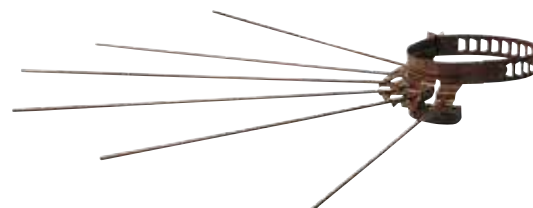

Disponibile fino ad esaurimento scorte • Available till sold out • Disponible jusqu'à épuisement du stock • Solange vorrat reicht