

[www.savefumisteria.it](http://www.savefumisteria.it)



Pellet



Wood



Air

catalogo  
**2021B**

**save**



LINEA

## Pellet

5 Pellet

9 Pellet **LIGHT**

13 Accessori Pellet - Pellet accessories



LINEA

## Wood

20 Plus 1,2mm

28 Plus **LIGHT**

33 Accessori Plus - Plus accessories

39 Classic



LINEA

## Air

48 Zincato - Galvanised

50 Flessibile Alluminio - Aluminium Flexible Pipes



# Legenda Designazione Prodotti

## Designation product legend

	Canale da fumo / Flue pipe	EN 1856-2	T600	N1	W	V2	L80100	G450NM
Descrizione del prodotto / Product description								
Norma di riferimento / Reference standard								
Resistenza alla temperatura (il numero indica la temperatura max) Temperature class (the number indicates the max. temperature)								
Livello di tenuta (N1 = depressione P1 = pressione) Pressure class (N1 = negative pressure P1 = pressure)								
Resistenza alla condensa (W = può funzionare in presenza di condensa; D = può funzionare solo a secco) Condensate resistance (W = can operate in the presence of condensate; D = can operate only dry)								
Resistenza alla corrosione (V1-V2-V3 = ha superato il test di corrosione rispettivo Vm = non è stato sottoposto a test di corrosione, ma il materiale risulta inserito nella tabella dei materiali consentiti e ne viene indicato il tipo e lo spessore) Corrosion resistance (V1-V2-V3 = passed the respective corrosion test Vm = did not undergo the corrosion test, but the material is included in the table of permitted materials and the type and thickness are indicated)								
Specifiche del materiale = le prime 3 cifre (L80) indicano il tipo di materiale, le seconde 3 (100) lo spessore del metallo Material specifications = the first 3 figures (L80) indicate the type of material, the second 3 (100) the thickness of the metal								
Resistenza al fuoco da fuliggine (G = sì; O = no) Il numero indica la distanza in millimetri da materiali infiammabili Soot-fire resistance (G = yes; O = no) The number in brackets represents the distance in millimetres from inflammable materials								

## Designazioni secondo la norma EN 1856-2 dei prodotti SAVE

### Product designation according to standard EN 1856-2

#### Pellet

Ø 8 - 10 - 12cm

##### Con guarnizioni - With gasket

T250\* - P1 - W - V2 - L80120 - O100

\* La classe T250 è stata ottenuta con le guarnizioni in Viton  
\* Temperature class T250 achieved with Viton gaskets

##### Senza guarnizioni - Without gasket

T600 - N1 - W - V2 - L80120 - G375NM  
T600 - N1 - W - V2 - L80120 - O360  
T450 - N1 - W - V2 - L80120 - G375NM  
T450 - N1 - W - V2 - L80120 - O300

#### Pellet **LIGHT**

Ø 8 - 10 - 12cm

##### Con guarnizioni - With gasket

T250\* - P1 - W - V2 - L80070 - O100

\* La classe T250 è stata ottenuta con le guarnizioni in Viton  
\* Temperature class T250 achieved with Viton gaskets

##### Senza guarnizioni - Without gasket

T600 - N1 - W - V2 - L80070 - G375NM  
T600 - N1 - W - V2 - L80070 - O360  
T450 - N1 - W - V2 - L80070 - G375NM  
T450 - N1 - W - V2 - L80070 - O300

#### Plus 1,2mm

Ø 10 - 12 - 12,5 - 13 - 14 - 15 - 15,3 - 16 - 18 - 20cm

T600 - N1 - W - V2 - L80120 - G600NM  
T600 - N1 - W - V2 - L80120 - O600  
T450 - N1 - W - V2 - L80120 - G600NM  
T450 - N1 - W - V2 - L80120 - O450

#### Plus **LIGHT**

Ø 12 - 12,5 - 13 - 14 - 15 - 15,3cm

T600 - N1 - W - V2 - L80070 - G600NM  
T600 - N1 - W - V2 - L80070 - O600  
T450 - N1 - W - V2 - L80070 - G600NM  
T450 - N1 - W - V2 - L80070 - O450

#### Classic

Ø 8 - 9 - 10 - 11 - 12 - 13 - 14 - 15cm

T600 - N1 - D - V2 - L80055 - G450NM  
T600 - N1 - D - V2 - L80055 - O450  
T450 - N1 - D - V2 - L80055 - G450NM  
T450 - N1 - D - V2 - L80055 - O350

[www.savefumisteria.it](http://www.savefumisteria.it) ►

Troverete informazioni dettagliate su ogni prodotto, indicazioni sulle particolarità dei pezzi speciali, le istruzioni di montaggio e le Dop, i disegni tecnici e molto altro!

You will find detailed information on each product, related Declaration Of Performances (DoP) and assembly instructions, all the specifications about our special pieces, technical drawings and much more!



**kiwa**



[www.hetas.co.uk](http://www.hetas.co.uk)

Prodotti Save approvati da Hetas  
**Hetas approved products**

## Pellet

Ø 10 - 12cm

T600 - N1 - W - V2 - L80120 - G375NM  
T450 - N1 - W - V2 - L80120 - G375NM

## Pellet **LIGHT**

Ø 10 - 12cm

T600 - N1 - W - V2 - L80070 - G375NM  
T450 - N1 - W - V2 - L80070 - G375NM

## Plus 1,2mm

Ø 10 - 12 - 12,5 - 13 - 14 - 15 - 15,3 - 16 - 18 - 20cm

T600 - N1 - W - V2 - L80120 - G600NM  
T450 - N1 - W - V2 - L80120 - G600NM

## Plus **LIGHT**

Ø 10 - 12 - 12,5 - 13 - 14 - 15 - 15,3 - 16 - 18 - 20cm

T600 - N1 - W - V2 - L80070 - G600NM  
T450 - N1 - W - V2 - L80070 - G600NM



LINEA

# Pellet

La linea di tubi specifica  
per stufe a pellet

Range of flue pipes specially  
designed for pellet stoves



# Pellet

Tubi per stufe a pellet porcellanati  
Vitreous enamelled pipes for pellet stoves  
Tubes pour poêles à pellets (granulés de bois)  
Emallierte Rohre für Pelletöfen



DoP N°3 - Pellet

www.savefumisteria.it &gt; Download

## GAMMA COLORI COLOR RANGE



Nero opaco  
Matt black  
Noir mat  
Mattschwarz



Nero ultra matt  
Ultramatt black  
Noir ultramat  
Schwarz ultramatt

## CARATTERISTICHE FEATURES

E' una linea di canali da fumo appositamente studiata per le stufe a pellet che, avendo un ventilatore nel circuito di combustione, richiedono l'utilizzo di guarnizioni di tenuta.

Costruiti in acciaio al carbonio saldati a laser per ottenere saldature perfette, successivamente ricoperti internamente ed esternamente con smalto vetroporcellanato cotto alla temperatura di 850°C per conferire eccezionali qualità di resistenza alla corrosione delle condense di combustione.

Resistono perfettamente anche a situazioni estreme come il fuoco di fuliggine (incendio che avviene dentro il tubo) senza rovinarsi o alterarsi; naturalmente nel caso in cui si verifichi il fuoco di fuliggine è necessario controllare che le guarnizioni non si siano deteriorate ed eventualmente sostituirle.

**La Dichiarazione di Prestazioni (DoP) n°3 Pellet è disponibile sul sito [www.savefumisteria.it](http://www.savefumisteria.it) alla pagina "download", con tutti i riferimenti ai test eseguiti e le istruzioni di montaggio e manutenzione a garanzia di assoluta sicurezza nell'utilizzo.**

Sul nostro sito [www.savefumisteria.it](http://www.savefumisteria.it) sono disponibili informazioni più dettagliate su ogni singolo prodotto.

This is a range of flue pipes specially designed for pellet stoves which require the use of gaskets, as they have a fan in the combustion circuit.

Laser-welding ensures these carbon steel pipes perfect welding. Subsequent internal/external vitreous enamel coating baked to 850°C provides exceptional resistance against corrosion by combustion condensate.

They are perfectly resistant even to extreme situations such as soot-fire (a fire that occurs inside the pipe) without being damaged or modified; obviously, if a soot-fire should occur, the gaskets must be checked for signs of deterioration and changed if necessary.

**The Declaration of Performance (DoP) n°3 Pellet is available at [www.savefumisteria.it](http://www.savefumisteria.it) in the download area, with reference to all the tests performed and Installation and Maintenance Instructions to ensure the greatest safety during use.**

More detailed information about each products are available on our website [www.savefumisteria.it](http://www.savefumisteria.it)

## GUARNIZIONI GASKET

LE GUARNIZIONI SONO, A SCELTA, DI 2 TIPI:

### IN SILICONE NERO

Classe di tenuta: P1 - Resistenza alla temperatura: 200°C

### IN VITON VERDE

Classe di tenuta: P1 - Resistenza alla temperatura: 250°C

LA TENUTA DEI NOSTRI TUBI PER STUFE A PELLETT È TESTATA E GARANTITA P1 **ESCLUSIVAMENTE** CON LE GUARNIZIONI DA NOI FORNITE.

THERE IS A CHOICE OF 2 TYPES OF GASKETS:

### BLACK SILICON GASKET

Pressure class: P1 - Temperature resistance: 200°C

### GREEN VITON GASKET

Pressure class: P1 - Temperature resistance: 250°C

THE TIGHTNESS OF OUR PIPES FOR PELLETT STOVE IS TESTED AND GUARANTEED P1 **EXCLUSIVELY** WITH THE GASKETS WE SUPPLY.



Le guarnizioni non sono comprese • The gaskets are not included • Les joints ne sont pas compris • Die Dichtungen sind nicht enthalten

## DESIGNAZIONI DESIGNATION

### SENZA GUARNIZIONE - WITHOUT GASKET

⊕ EN 1856-2 - T600 - N1 - W - V2 - L80120 - G375NM

⊕ EN 1856-2 - T600 - N1 - W - V2 - L80120 - O360

⊕ EN 1856-2 - T450 - N1 - W - V2 - L80120 - G375NM

⊕ EN 1856-2 - T450 - N1 - W - V2 - L80120 - O300

### CON GUARNIZIONE - WITH GASKET

⊕ EN 1856-2 - T250\* - P1 - W - V2 - L80120 - O100

\* La classe T250 è stata ottenuta con la guarnizione in Viton

\* Temperature class T250 achieved with Viton gaskets

# Tubi Pellet

porcellanati in nero opaco  
e nero ultra matt

Matt black and ultra matt black  
vitreous enamelled pipes for pellet stoves

Tubes émaillés en noir mat et  
noir ultra mat pour poêles à pellets

Mattschwarz und ultra mattschwarz  
emailierte Rohre für Pelletöfen



Le guarnizioni non sono comprese • The gaskets are not included • Les joints ne sont pas compris • Die Dichtungen sind nicht enthalten

Øcm	color	L 100cm		L 50cm		L 25cm		L 150cm	
		cod.	Pack	cod.	Pack	cod.	Pack	cod.	Pack
8	N	PN800	4	PN801	4	PN802	4	PN840	4
	U	PU800	4	PU801	4	PU802	4	-	-
10	N	PN1000	4	PN1001	4	PN1002	4	-	-
12	N	PN1200	4	PN1201	4	PN1202	4	-	-



# Set Tubi telescopici H50cm e H33cm Pellet

porcellanati in nero opaco  
e nero ultra matt

Matt black and ultra matt black vitreous enamelled  
Telescopic Set Pellet h.50cm and h.33cm

Set Télescopique Pellet h.50cm et h.33cm émaillés  
en noir mat et noir ultra mat pour poêle à pellets

Gruppe ausziehbarer emailierter Rohre (h.50cm und  
h.33cm) in mattschwarz und ultra mattschwarz für  
Pelletöfen



Le guarnizioni non sono comprese • The gaskets are not included • Les joints ne sont pas compris • Die Dichtungen sind nicht enthalten

Øcm	color	H 50cm		H 33cm	
		cod.	Pack	cod.	Pack
8	N	PN843	1	PN842	1
	U	-	-	PU842*	1
10	N	PN1043	1	PN1042	1
12	N	-	-	PN1242	1



Disponibile fino ad esaurimento scorte • Available till sold out • Disponible jusqu'à épuisement du stock • Solange vorrat reicht



# Gomiti e Gomiti con ispezione Pellet

porcellanati in nero opaco  
e nero ultra matt

Matt black and ultra matt black vitreous enamelled 90°, 45°,  
90° M/M and 90° with inspection elbows for pellet stoves

Coudes émaillés 90°, 45°, 90° mâle-mâle et 90° avec trappe de visite  
en noir mat et noir ultra mat pour poêles à pellets

Mattschwarz und ultra mattschwarz emailierte Knie mit 90°-, 45°-,  
90°-Winkel Außengewinde/Außengewinde und 90°-Winkel  
und Reinigungsöffnung für Pelletöfen

**!** Le guarnizioni non sono comprese • The gaskets are not included • Les joints ne sont pas compris • Die Dichtungen sind nicht enthalten

Øcm	color	90°		45°		90°M/M		90° ISPEZ.	
		cod.	Pack	cod.	Pack	cod.	Pack	cod.	Pack
8	<b>N</b>	PN803	4	PN804	4	PN803M	4	PN808	1
	<b>U</b>	PU803	4	PU804	4	-	-	PU808	1
10	<b>N</b>	PN1003	4	PN1004	4	PN1003M*	4	PN1008	1
12	<b>N</b>	PN1203	4	PN1204	4	PN1203M*	4	PN1208	1



\*  Disponibile fino ad esaurimento scorte • Available till sold out • Disponible jusqu'à épuisement du stock • Solange vorrat reicht

# Tubi a "T" Pellet

porcellanati in nero opaco  
e nero ultra matt

Matt black and ultra matt black vitreous enamelled  
female/female or male/female T-pieces for pellet stoves

Tés émaillés femelle-femelle ou mâle-femelle en noir mat  
et noir ultra mat pour poêles à pellets

Innengewinde/Innengewinde oder Außengewinde/Innengewinde  
mattschwarz und ultra mattschwarz emailierte T-Stücke  
für Pelletöfen

**!** Le guarnizioni non sono comprese • The gaskets are not included • Les joints ne sont pas compris • Die Dichtungen sind nicht enthalten

Øcm	color	F/F		M/F		F/F ridotto a Ø8cm	
		cod.	Pack	cod.	Pack	cod.	Pack
8	<b>N</b>	PN805F	4	PN805M	4	-	-
	<b>U</b>	PU805F	4	PU805M	4	-	-
10	<b>N</b>	PN1005F	4	PN1005M	4	PN1005/8F	4
12	<b>N</b>	PN1205F	4	PN1205M	4	-	-



# Tappi per tubi a "T" Pellet

porcellanati in nero opaco e nero ultra matt

Matt black and ultra matt black vitreous enamelled plugs for T-pieces for pellet stoves

Tampons pour tés émaillés en noir mat et noir ultra mat pour poêles à pellets

Mattschwarz und ultra mattschwarz emailierte Verschlussstücke für T-Stücke für Pelletöfen



Le guarnizioni non sono comprese • The gaskets are not included • Les joints ne sont pas compris • Die Dichtungen sind nicht enthalten

Øcm	color	A		B	
		cod.	Pack	cod.	Pack
8	<b>N</b>	PN819C	12	PN818	12
	<b>U</b>	PU819C	12	PU818	12
10	<b>N</b>	PN1019C	12	PN1018*	12
12	<b>N</b>	PN1219C	12	-	-



**A**  
Ciechi  
Blind  
Plein



**B**  
Con manicotto in ottone  
With brass coupling  
Avec manchon en laiton  
Mit Messingmuffe



Disponibile fino ad esaurimento scorte • Available till sold out • Disponible jusqu'à épuisement du stock • Solange vorrat reicht

# Fascette di blocco per tappi

in acciaio inox verniciato nero

Pipe clamps for plugs in steel matt black painted

Colliers serre-tube pour tampons laques noir mat

Befestigungsschellen für Verschlussstücke aus Stahl mattschwarz Lackierte



NOTA: da utilizzare con guarnizioni in fibra di vetro • NOTE: use fibreglass gaskets • REMARQUE: à utiliser avec les joints thermiques en fibre de verre • HINWEIS: mit Glasfaserdichtungen zu verwenden

Øcm	color	cod.	Pack
8	<b>N</b>	PN813	1
10	<b>N</b>	PN1013	1



# Raccordi Pellet

porcellanati in nero opaco e nero ultra matt

Matt black and ultra matt black vitreous enamelled female-female or male-male fittings for pellet stoves

Raccords émaillés femelle-femelle ou mâle-mâle en noir mat et noir ultra mat pour poêles à pellets

Mattschwarz und ultra mattschwarz emailierte Anschlüsse für Pelletöfen Innengewinde/Innengewinde oder Außengewinde/Außengewinde



Le guarnizioni non sono comprese • The gaskets are not included • Les joints ne sont pas compris • Die Dichtungen sind nicht enthalten

Øcm	color	F/F		M/M	
		cod.	Pack	cod.	Pack
8	<b>N</b>	PN817F	2	PN817M	2
	<b>U</b>	PU817F	2	PU817M	2
10	<b>N</b>	PN1017F	2	PN1017M	2
12	<b>N</b>	PN1217F*	2	PN1217M*	2



F/F



M/M



Disponibile fino ad esaurimento scorte • Available till sold out • Disponible jusqu'à épuisement du stock • Solange vorrat reicht

# Pellet LIGHT



Tubi per stufe a pellet porcellanati  
Vitreous enamelled pipes for pellet stoves  
Tubes pour poêles à pellets (granulés de bois)  
Emaillierte Rohre für Pelletöfen



## GAMMA COLORI COLOR RANGE

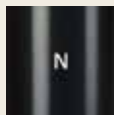

Nero opaco  
Matt black  
Noir mat  
Mattschwarz

## CARATTERISTICHE FEATURES

Questi tubi sono più leggeri ed economici rispetto alla linea Pellet, pur mantenendo tutte le caratteristiche normative e prestazionali. Sono perfettamente compatibili sia dal punto di vista tecnico per imbrocchi e dimensioni, sia dal punto di vista estetico per l'uguale finitura in smalto porcellanato.

E' una linea di canali da fumo appositamente studiata per le stufe a pellet che, avendo un ventilatore nel circuito di combustione, richiedono l'utilizzo di guarnizioni di tenuta.

Costruiti in acciaio al carbonio saldati a laser per ottenere saldature perfette, successivamente ricoperti internamente ed esternamente con smalto vetroporcellanato cotto alla temperatura di 850°C per conferire eccezionali qualità di resistenza alla corrosione delle condense di combustione.

Resistono perfettamente anche a situazioni estreme come il fuoco di fuliggine (incendio che avviene dentro il tubo) senza rovinarsi o alterarsi; naturalmente nel caso in cui si verifichi il fuoco di fuliggine è necessario controllare che le guarnizioni non si siano deteriorate ed eventualmente sostituirle.

**La Dichiarazione di Prestazioni (DoP) n°5 Pellet Light è disponibile sul sito [www.savefumisteria.it](http://www.savefumisteria.it) alla pagina "download", con tutti i riferimenti ai test eseguiti e le istruzioni di montaggio e manutenzione a garanzia di assoluta sicurezza nell'utilizzo.**

Sul nostro sito [www.savefumisteria.it](http://www.savefumisteria.it) sono disponibili informazioni più dettagliate su ogni singolo prodotto.

These pipes are lighter and less expensive than the Pellet line, while maintaining all the characteristics and performance standards. They are fully compatible with both the technical point of view - thanks to the same connections and dimensions - and the aesthetic point of view, thanks to the same enamel coating.

This is a range of flue pipes specially designed for pellet stoves which require the use of gaskets, as they have a fan in the combustion circuit.

Laser-welding ensures these carbon steel pipes perfect welding. Subsequent internal/external vitreous enamel coating baked to 850°C provides exceptional resistance against corrosion by combustion condensate.

They are perfectly resistant even to extreme situations such as soot-fire (a fire that occurs inside the pipe) without being damaged or modified; obviously, if a soot-fire should occur, the gaskets must be checked for signs of deterioration and changed if necessary.

**The Declaration of Performance (DoP) n°5 Pellet Light is available at [www.savefumisteria.it](http://www.savefumisteria.it) in the download area, with reference to all the tests performed and Installation and Maintenance Instructions to ensure the greatest safety during use.**

More detailed information about each products are available on our website [www.savefumisteria.it](http://www.savefumisteria.it)

## GUARNIZIONI GASKET

LE GUARNIZIONI SONO, A SCELTA, DI 2 TIPI:

### IN SILICONE NERO

Classe di tenuta: P1 - Resistenza alla temperatura: 200°C

### IN VITON VERDE

Classe di tenuta: P1 - Resistenza alla temperatura: 250°C

LA TENUTA DEI NOSTRI TUBI PER STUFE A PELLET È TESTATA E GARANTITA P1 **ESCLUSIVAMENTE** CON LE GUARNIZIONI DA NOI FORNITE.

THERE IS A CHOICE OF 2 TYPES OF GASKETS:

### BLACK SILICON GASKET

Pressure class: P1 - Temperature resistance: 200°C

### GREEN VITON GASKET

Pressure class: P1 - Temperature resistance: 250°C

THE TIGHTNESS OF OUR PIPES FOR PELLET STOVE IS TESTED AND GUARANTEED P1 **EXCLUSIVELY** WITH THE GASKETS WE SUPPLY.



Le guarnizioni non sono comprese • The gaskets are not included • Les joints ne sont pas compris • Die Dichtungen sind nicht enthalten

## DESIGNAZIONI DESIGNATION

### SENZA GUARNIZIONE - WITHOUT GASKET

⊕ EN 1856-2 - T600 - N1 - W - V2 - L80070 - G375NM

⊕ EN 1856-2 - T600 - N1 - W - V2 - L80070 - O360

⊕ EN 1856-2 - T450 - N1 - W - V2 - L80070 - G375NM

⊕ EN 1856-2 - T450 - N1 - W - V2 - L80070 - O300

### CON GUARNIZIONE - WITH GASKET

⊕ EN 1856-2 - T250\* - P1 - W - V2 - L80070 - O100

\* La classe T250 è stata ottenuta con la guarnizione in Viton

\* Temperature class T250 achieved with Viton gaskets

# Tubi Pellet **LIGHT**

porcellanati in nero opaco

Matt black vitreous enamelled pipes for pellet stoves

Tubes émaillés en noir mat pour poêles à pellets

Mattschwarz emailierte Rohre für Pelletöfen



Le guarnizioni non sono comprese • The gaskets are not included • Les joints ne sont pas compris • Die Dichtungen sind nicht enthalten

Øcm	color	L 100cm		L 50cm		L 25cm	
		cod.	Pack	cod.	Pack	cod.	Pack
8	N	PNL800	6	PNL801	6	PNL802	6
10	N	PNL1000	6	PNL1001	6	PNL1002	6
12	N	PNL1200	6	PNL1201	6	PNL1202	6



# Set Tubi telescopici H50cm e H33cm Pellet **LIGHT**

porcellanati in nero opaco

Matt black vitreous enamelled Telescopic  
Set Pellet Light h.50cm and h.33cmSet Télescopique Pellet Light h.50cm et h.33cm  
émaillés en noir mat pour poêle à pelletsGruppe ausziehbarer emailierter Rohre (h.50cm  
und h.33cm) in mattschwarz für Pelletöfen

Le guarnizioni non sono comprese • The gaskets are not included • Les joints ne sont pas compris • Die Dichtungen sind nicht enthalten

Øcm	color	H 50cm		H 33cm	
		cod.	Pack	cod.	Pack
8	N	PNL843	1	PNL842	1
10	N	PNL1043*	1	PNL1042*	1



Disponibile fino ad esaurimento scorte • Available till sold out • Disponible jusqu'à épuisement du stock • Solange vorrat reicht

# Gomiti e Gomiti con ispezione Pellet

porcellanati in nero opaco

Matt black vitreous enamelled 90°, 45°, 90° M/M and 90° with inspection elbows for pellet stoves  
Coudes émaillés 90°, 45°, 90° mâle-mâle et 90° avec trappe de visite en noir mat pour poêles à pellets  
Mattschwarz emailierte Knie mit 90°, 45°, 90°-Winkel Außengewinde/Außengewinde und 90°-Winkel und Reinigungsöffnung für Pelletöfen

100% compatible with  
Pellet LIGHT

**!** Le guarnizioni non sono comprese • The gaskets are not included • Les joints ne sont pas compris • Die Dichtungen sind nicht enthalten

Øcm	color	90°		45°		90°M/M		90° ISPEZ.	
		cod.	Pack	cod.	Pack	cod.	Pack	cod.	Pack
8	N	PN803	4	PN804	4	PN803M	4	PN808	1
10	N	PN1003	4	PN1004	4	PN1003M*	4	PN1008	1
12	N	PN1203	4	PN1204	4	PN1203M*	4	PN1208	1





\*  Disponibile fino ad esaurimento scorte • Available till sold out • Disponible jusqu'à épuisement du stock • Solange vorrat reicht

# Tubi a "T" Pellet



porcellanati in nero opaco

Matt black vitreous enamelled female/female or male/female T-pieces for pellet stoves  
Tés émaillés femelle-femelle ou mâle-femelle en noir mat pour poêles à pellets  
Innengewinde/Innengewinde oder Außengewinde/Innengewinde mattschwarz emailierte T-Stücke für Pelletöfen

100% compatible with  
Pellet LIGHT

**!** Le guarnizioni non sono comprese • The gaskets are not included • Les joints ne sont pas compris • Die Dichtungen sind nicht enthalten

Øcm	color	F/F		M/F		F/F ridotto a Ø8cm	
		cod.	Pack	cod.	Pack	cod.	Pack
8	N	PN805F	4	PN805M	4	-	-
10	N	PN1005F	4	PN1005M	4	PN1005/8F	4
12	N	PN1205F	4	PN1205M	4	-	-

# Tappi per tubi a "T" Pellet

porcellanati in nero opaco

Matt black vitreous enamelled  
plugs for T-pieces for pellet stoves

Tampons pour tés émaillés en noir mat  
pour poêles à pellets

Mattschwarz emailierte Verschlussstücke  
für T-Stücke für Pelletöfen

100% compatible with  
**Pellet LIGHT**



Le guarnizioni non sono comprese • The gaskets are not included • Les joints ne sont pas compris • Die Dichtungen sind nicht enthalten

Øcm	color	A		B	
		cod.	Pack	cod.	Pack
8	N	PN819C	12	PN818	12
10	N	PN1019C	12	PN1018*	12
12	N	PN1219C	12	-	-



**A**  
Ciechi  
Blind  
Plein



**B**  
Con manicotto in ottone  
With brass coupling  
Avec manchon en laiton  
Mit Messingmuffe



Disponibile fino ad esaurimento scorte • Available till sold out • Disponible jusqu'à épuisement du stock • Solange vorrat reicht

# Fascette di blocco per tappi

in acciaio inox verniciato nero

Pipe clamps for plugs in  
steel matt black painted

Colliers serre-tube pour tampons  
laques noir mat

Befestigungsschellen für Verschlussstücke  
aus Stahl mattschwarz Lackierte

100% compatible with  
**Pellet LIGHT**



NOTA: da utilizzare con guarnizioni in fibra di vetro • NOTE: use fibreglass gaskets • REMARQUE: à utiliser avec les joints thermiques en fibre de verre • HINWEIS: mit Glasfaserdichtungen zu verwenden

Øcm	color	cod.	Pack
8	N	PN813	1
10	N	PN1013	1



# Raccordi Pellet

porcellanati in nero opaco

Matt black vitreous enamelled female-female  
or male-male fittings for pellet stoves

Raccords émaillés femelle-femelle  
ou mâle-mâle en noir mat pour poêles à pellets

Mattschwarz emailierte Anschlüsse  
für Pelletöfen Innengewinde/Innengewinde  
oder Außengewinde/Außengewinde

100% compatible with  
**Pellet LIGHT**



Le guarnizioni non sono comprese • The gaskets are not included • Les joints ne sont pas compris • Die Dichtungen sind nicht enthalten

Øcm	color	F/F		M/M	
		cod.	Pack	cod.	Pack
8	N	PN817F	2	PN817M	2
10	N	PN1017F	2	PN1017M	2
12	N	PN1217F*	2	PN1217M*	2



F/F



M/M



Disponibile fino ad esaurimento scorte • Available till sold out • Disponible jusqu'à épuisement du stock • Solange vorrat reicht

LINEA PELLETT

# Accessori Pellet & Pellet **LIGHT**

Accessori "PELLET & PELLETT LIGHT" in nero opaco e nero ultra matt

Matt black and ultra matt black "PELLET" accessories

Accessoires "PELLET" en noir mat et noir ultra mat

Accessoires Baureihe "PELLET" in mattschwarz und ultra mattschwarz

## GAMMA COLORI COLOR RANGE

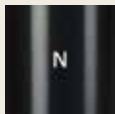

Nero opaco  
Matt black  
Noir mat  
Mattschwarz

### ATTENZIONE:

Tutti gli accessori verniciati sono compatibili con le finiture smaltate nero opaco e nero ultra matt.

### ATTENTION:

All black painted accessories are compatible with vitreous enamelled finishes in matt black and ultra matt black.

### AVERTISSEMENT:

Tous les accessoires en peinture noire sont compatibles avec les finitions en emaille noir mat et noir ultra matt.

### ACHTUNG:

Alle schwarz lackierte Zubehöre sind kompatibel mit emallierte Rohre in mattschwarz und ultra mattschwarz.

## CARATTERISTICHE FEATURES

Tutti gli Accessori PELLETT SAVE sono appositamente studiati per essere perfettamente adattabili alle linee Pellet e Pellet Light.

Questa linea è appositamente studiata per le stufe a pellet che, avendo un ventilatore nel circuito di combustione, richiedono l'utilizzo di guarnizioni di tenuta.

SUL NOSTRO SITO [www.savefumisteria.it](http://www.savefumisteria.it) SONO DISPONIBILI INFORMAZIONI PIÙ DETTAGLIATE SU OGNI SINGOLO PRODOTTO.

All the PELLETT SAVE accessories have been specifically designed to fit the Pellet and Pellet Light.

This is a range of flue pipes specially designed for pellet stoves which require the use of gaskets, as they have a fan in the combustion circuit.

MORE DETAILED INFORMATION ABOUT EACH PRODUCTS ARE AVAILABLE ON OUR WEBSITE [www.savefumisteria.it](http://www.savefumisteria.it)

## GUARNIZIONI GASKET

LE GUARNIZIONI SONO, A SCELTA, DI 2 TIPI:

### IN SILICONE NERO

Classe di tenuta: P1 - Resistenza alla temperatura: 200°C

### IN VITON VERDE

Classe di tenuta: P1 - Resistenza alla temperatura: 250°C

THERE IS A CHOICE OF 2 TYPES OF GASKETS:

### BLACK SILICON GASKET

Pressure class: P1 - Temperature resistance: 200°C

### GREEN VITON GASKET

Pressure class: P1 - Temperature resistance: 250°C

LA TENUTA DEI NOSTRI TUBI PER STUFE A PELLETT È TESTATA E GARANTITA P1 **ESCLUSIVAMENTE** CON LE GUARNIZIONI DA NOI FORNITE.

THE TIGHTNESS OF OUR PIPES FOR PELLETT STOVE IS TESTED AND GUARANTEED P1 **EXCLUSIVELY** WITH THE GASKETS WE SUPPLY.

 Le guarnizioni non sono comprese • The gaskets are not included • Les joints ne sont pas compris • Die Dichtungen sind nicht enthalten

Pellet

Pellet

Pellet  
**LIGHT**

Accessori  
Pellet

LINEA PELLETT  
AccessoriNero opaco • Matt black  
Noir mat • Mattschwarz

Pellet &amp; Pellet Light

# Guarnizioni

in silicone e viton

Silicon and Viton Gaskets  
Joints en silicone et Viton  
Silikondichtungen und VitondichtungenLA TENUTA DEI NOSTRI TUBI PER STUFE A PELLETT È TESTATA  
E GARANTITA P1 **ESCLUSIVAMENTE** CON LE GUARNIZIONI  
DA NOI FORNITE.THE TIGHTNESS OF OUR PIPES FOR PELLETT STOVE IS TESTED  
AND GUARANTEED P1 **EXCLUSIVELY** WITH THE GASKETS  
WE SUPPLY.Guarnizione in silicone  
Silicon gaskets  
Joints en silicone  
SilikondichtungenGuarnizione in viton  
Viton gaskets  
Joints en viton  
Vitondichtungen

Øcm	cod.	Pack	cod.	Pack
8	AS819	10	AS819V	10
10	AS1019	10	AS1019V	10
12	AS1219	10	AS1219V	10



Pellet &amp; Pellet Light

# Anelli Pellet

verniciati in nero opaco  
e anelli in silicone neroMatt black painted pellet ring  
and black silicon ring  
Anneaux laqués noir mat pour poêle  
à pellets and anneaux en silicone noir  
Mattschwarz lackierte Ringe und  
Schwarzen Silikonringe für Pelletofen

Øcm	color	90°		90° MAXI		45°		90° SILICONE	
		cod.	Pack	cod.	Pack	cod.	Pack	cod.	Pack
8	N	NN810	10	NN822	10	NN814	10	NN811	1
10	N	NN1010	10	-	-	-	-	NN1011	1
12	N	NN1210	10	-	-	-	-	-	-



Ø +9cm



Ø +17cm





Pellet & Pellet Light

# Kit fissaggio magnetico per anelli

Magnetic fixing kit for rings  
Magnetic kit de montage pour les anneaux  
Magnetischer Montage-Kit für Ringe

cod.	Pack
NNFIX	20



Pellet & Pellet Light

# Rosoni Pellet

verniciati in nero opaco

Matt black painted pellet covers  
Rosaces émaillées laquées noir mat pour poêles à pellets  
Mattschwarz lackierte 1,2-mm-Rosetten für Pelletöfen

**!** Le guarnizioni non sono comprese • The gaskets are not included • Les joints ne sont pas compris • Die Dichtungen sind nicht enthalten

ROSONE - COVERS - ROSACES - ROSETTEN

MAXI ROSONE - MAXI COVERS  
MAXI ROSACES - MAXI ROSETTEN

Øcm	color	cod.	Pack	cod.	Pack
8	N	PN809	5	PN841	5
10	N	PN1009	5	-	-
12	N	PN1209	5	-	-



LINEA PELLETT  
AccessoriGAMMA  
COLORINero opaco • Matt black  
Noir mat • Mattschwarz

Pellet &amp; Pellet Light

# Reggitubo Pellet

verniciati in nero opaco

Matt black painted stainless steel  
pellet pipe holderPorte-tubes laqué noir mat  
pour poêles à pelletsMattschwarz lackierter Rohrhalter  
mit Dübel für Pelletöfen

Øcm	color	cod.	Pack
8	N	NN28	10
10	N	NN210	10
12	N	NN212	10



Pellet &amp; Pellet Light

# Raccordi telescopici a soffitto Pellet

verniciati in nero opaco

Matt black painted telescopic  
ceiling fittings for pellet stovesRaccords télescopiques plafond  
laqués noir mat pour poêles à pelletsAusziehbares Deckenanschlussstück,  
mattschwarz lackiert für Pelletöfen

Le guarnizioni non sono comprese • The gaskets are not included • Les joints ne sont pas compris • Die Dichtungen sind nicht enthalten

FEMMINA - FEMALE - FEMELLE - INNENGEWINDE

MASCHIO - MALE - MÂLE - AUßENGEWINDE

Øcm	color	cod.	Pack	cod.	Pack
8	N	PN811F	1	PN811M	1



Pellet & Pellet Light

# Riduzioni Pellet

porcellanate in nero opaco

Matt black vitreous enamelled  
reducers for pellet stoves  
Réductions émaillées en noir mat  
pour poêles à pellets  
Mattschwarz emailierte  
Reduzierstücke für Pelletöfen

Øcm	color	cod.	Pack
12F / 10M	N	PN12F/10M	2
12F / 8M	N	PN12F/8M	2
10F / 8M	N	PN10F/8M	2
8F / 10M	N	PN8F/10M	2



Pellet & Pellet Light

# Terminali di scarico

in acciaio inox

Stainless steel exhaust terminal unit  
Pièce terminale de dégagement en acier inox  
Rauchabzugsstutzen aus Edelstahl

Øcm	color	cod.	Pack
8	A	AL824	10
10	A	AL1024	10





# Kit di installazione base tubi Pellet **LIGHT**

porcellanati in nero opaco

Basic installation kit, matt black  
vitreous enamelled pellet flue pipes  
Kit d'installation base, tuyaux pellet  
emailles en noir mat

Grund-Installation Kit, Pellet Rohre  
in Mattschwarz

- 1 x Ø8cm x L100 cm
- 1 x Ø8cm x L50 cm
- 1 x Ø8cm 90°
- 1 x Ø8cm "T"
- 1 x Ø8cm tappo / plug / tampon / verschlussstucke
- 1 x anello / ring / anneau / ringe
- Guarnizioni / gaskets / joints / dichtungen

Øcm	color	cod.	Pack
8	N	PNLKIT	1

*Per installazioni in anticondensa*  
*For installation in the sense of condensate*  
*Pour installation dans le sens de la condensation*  
*Für Anti-Kondensat Installation*

Øcm	color	cod.	Pack
8	N	PNLKITF	1





LINEA

# Wood

**La linea di tubi specifica  
per stufe a legna**

**Range of flue pipes specially  
designed for wood stoves**



LINEA WOOD

# Plus 1,2 mm



Tubi per stufe a legna porcellanati  
Vitreous enamelled pipes for wood stove  
Tubes émaillé pour poêles à bois  
Emallierte Rohre für Holzofen



## GAMMA COLORI COLOR RANGE

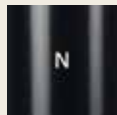

Nero opaco  
Matt black  
Noir mat  
Mattschwarz



Nero ultra matt  
Ultramatt black  
Noir ultramat  
Schwarz ultramatt



Grigio  
Grey  
Gris  
Grau

## CARATTERISTICHE FEATURES

Rappresentano il massimo qualitativo della produzione SAVE Spa: tubi in acciaio al carbonio saldati a laser per ottenere saldature perfette, vengono successivamente ricoperti internamente ed esternamente con smalto vetroporcellanato cotto a temperatura di 850°C per conferire eccezionali qualità di resistenza alla corrosione delle condense di combustione.

I risultati del test V2 previsto dalla norma 1856-2 sulla resistenza alla corrosione, hanno dimostrato che i canali da fumo Plus 1.2mm e Plus Light hanno una durata decisamente superiore ai normali tubi verniciati di sp. 2mm non vetrificati internamente.

Resistono perfettamente anche a situazioni estreme come il fuoco di fuliggine (incendio che avviene dentro il tubo) senza rovinarsi o alterarsi.

**La Dichiarazione di Prestazioni (DoP) n°2 Plus 1,2mm è disponibile sul sito [www.savefumisteria.it](http://www.savefumisteria.it) alla pagina "download", con tutti i riferimenti ai test eseguiti e le istruzioni di montaggio e manutenzione a garanzia di assoluta sicurezza nell'utilizzo.**

SUL NOSTRO SITO [www.savefumisteria.it](http://www.savefumisteria.it) SONO DISPONIBILI INFORMAZIONI PIÙ DETTAGLIATE SU OGNI SINGOLO PRODOTTO.

Representing the highest level of SAVE Spa quality, laser-welding ensures these carbon steel pipes perfect welding. Subsequent internal/external vitreous enamel coating baked to 850°C provides exceptional resistance against corrosion by combustion condensate.

V2 test results specified by corrosion resistance Standard 1856-2 show that Plus 1.2 mm and Plus Light flue pipes have a significantly longer duration than normally painted 2 mm thick pipes that have not received internal vitreous enamel coating.

They are perfectly resistant even to extreme situations such as soot-fire (a fire that occurs inside the pipe) without being damaged or modified.

**The Declaration of Performance (DoP) n°2 Plus 1,2mm is available at [www.savefumisteria.it](http://www.savefumisteria.it) in the download area, with reference to all the tests performed and Installation and Maintenance Instructions to ensure the greatest safety during use.**

MORE DETAILED INFORMATION ABOUT EACH PRODUCTS ARE AVAILABLE ON OUR WEBSITE [www.savefumisteria.it](http://www.savefumisteria.it)

## ANTICONDENSA ANTI-CONDENSATE

Per evitare la fuoriuscita di condensa è necessario che vengano montati con l'imbocco rivolto verso il basso (vedi disegno). Per fare questo può essere necessario usare come partenza il raccordo F/F anticondensa.

In order to prevent the leakage of condensate, they must be fitted with the inlet facing downwards (see drawing). To do this, it may be necessary to use an F/F anti-condensate fitting to start with.

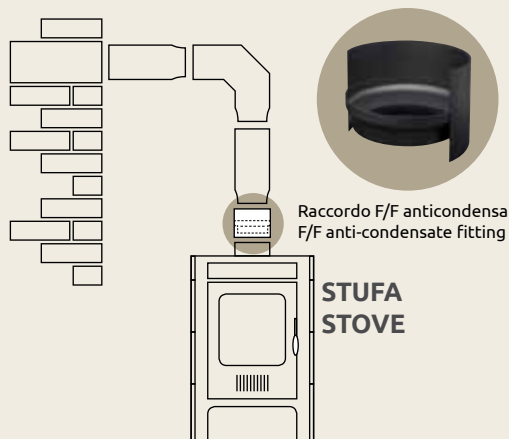

## DESIGNAZIONI DESIGNATION

- ⊕ EN 1856-2 – T600 – N1 – W – V2 – L80120 – G600NM
- ⊕ EN 1856-2 – T600 – N1 – W – V2 – L80120 – O600
- ⊕ EN 1856-2 – T450 – N1 – W – V2 – L80120 – G600NM
- ⊕ EN 1856-2 – T450 – N1 – W – V2 – L80120 – O450

# Tubi Plus 1,2 mm

porcellanati in nero opaco,  
nero ultra matt e grigio

Plus matt black, ultra matt black  
and grey vitreous enamelled pipes

Tubes émaillés Plus en noir mat,  
noir ultra mat et gris

Mattschwarz, ultra mattschwarz und grau  
emaillierte Plus Rohre

Øcm	color	L 100cm		L 50cm		L 25cm	
		cod.	Pack	cod.	Pack	cod.	Pack
10	N	NNO1000	4	NNO1001	4	NNO1002	4
12	N	NNO1200	4	NNO1201	4	NNO1202	4
12,5	N	NNO12500	4	NNO12501	4	NNO12502	4
	U	UU12500	4	UU12501	4	UU12502	4
13	N	NNO1300	4	NNO1301	4	NNO1302	4
14	N	NNO1400	4	NNO1401	4	NNO1402	4
15	N	NNO1500	4	NNO1501	4	NNO1502	4
	U	UU1500	4	UU1501	4	UU1502	4
	G	GGO1500*	1	GGO1501*	1	GGO1502*	1
15,3	N	NNO15300	4	NNO15301	4	NNO15302	4
16	N	NNO1600	1	NNO1601	1	NNO1602	1
18	N	NNO1800	1	NNO1801	1	NNO1802	1
	G	GGO1800*	1	GGO1801*	1	GGO1802*	1
20	N	NNO2000	1	NNO2001	1	NNO2002	1



Disponibile fino ad esaurimento scorte • Available till sold out • Disponible jusqu'à épuisement du stock • Solange vorrat reicht

# Tubi telescopici H50cm e H33cm Plus 1,2 mm

porcellanati in nero opaco,  
nero ultra matt e grigio

Plus matt black, ultra matt black and grey vitreous  
enamelled telescopic pipes h. 50 cm and h. 33 cm

Tubes émaillés télescopiques Plus h 50 cm et h 33 cm  
en noir mat, noir ultra mat et gris

Ausziehbare emaillierte Plus Rohre  
(h 50 cm und h 33 cm) in mattschwarz,  
ultra mattschwarz und grau

		H 50cm		H 33cm	
Øcm	color	cod.	Pack	cod.	Pack
12	N	-	-	NNO1220	1
12,5	N	NNO12521*	1	NNO12520	1
	U	-	-	UU12520	1
13	N	-	-	NNO1320	1
14	N	-	-	NNO1420	1
15	N	NNO1521	1	NNO1520	1
	U	-	-	UU1520	1
	G	GGO1521*	1	GGO1520*	1
15,3	N	NNO15321*	1	NNO15320	1
16	N	-	-	NNO1620*	1
18	N	NNO1821*	1	NNO1820	1
	G	GGO1821*	1	GGO1820*	1
20	N	NNO2021*	1	NNO2020	1

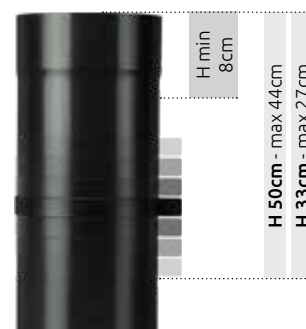

Disponibile fino ad esaurimento scorte • Available till sold out • Disponible jusqu'à épuisement du stock • Solange vorrat reicht

# Tubi con ispezione Plus 1,2 mm

porcellanati in nero opaco

Plus matt black vitreous  
enamelled pipes with inspection

Tubes émaillés Plus  
en noir mat avec trappe de visite

Mattschwarz emaillierte Plus  
Rohre und Reinigungsöffnung

		L 100m		L 50cm		L 33cm	
Øcm	color	cod.	Pack	cod.	Pack	cod.	Pack
12,5	N	NNO125008	1	NNO125018	1	NNO125028*	1
15	N	NNO15008	1	NNO15018	1	NNO15028*	1
18	N	NNO18008	1	NNO18018	1	NNO18028*	1



L 100m



Disponibile fino ad esaurimento scorte • Available till sold out • Disponible jusqu'à épuisement du stock • Solange vorrat reicht



# Gomiti Plus 1,2 mm

porcellanati in nero opaco,  
nero ultra matt e grigio

Plus matt black, ultra matt black and grey  
vitreous enamelled 90°, 45°, 30° and 15° elbows

Coudes émaillés Plus 90°, 45°, 30° et 15°  
en noir mat, noir ultra mat et gris

Mattschwarz, ultra mattschwarz und grau emailierte  
Plus Knie mit 90°, 45°, 30°, 15°-Winkel

Øcm	color	90°		45°		30°		15°	
		cod.	Pack	cod.	Pack	cod.	Pack	cod.	Pack
10	N	NNO1003	4	NNO1004	4	-	-	-	-
12	N	NNO1203	4	NNO1204	4	-	-	-	-
12,5	N	NNO12503	4	NNO12504	4	NNO12543	4	NNO12544	4
	U	UU12503	4	UU12504	4	-	-	-	-
13	N	NNO1303	4	NNO1304	4	-	-	-	-
14	N	NNO1403	4	NNO1404	4	-	-	-	-
15	N	NNO1503	4	NNO1504	4	NNO1543	4	NNO1544	4
	U	UU1503	4	UU1504	4	-	-	-	-
	G	GGO1503*	1	GGO1504*	1	-	-	-	-
15,3	N	NNO15303	4	NNO15304	4	-	-	-	-
16	N	NNO1603	1	NNO1604	1	-	-	-	-
18	N	NNO1803	1	NNO1804	1	-	-	-	-
	G	GGO1803*	1	GGO1804*	1	-	-	-	-
20	N	NNO2003	1	NNO2004	1	-	-	-	-



Disponibile fino ad esaurimento scorte • Available till sold out • Disponible jusqu'à épuisement du stock • Solange vorrat reicht

# Gomiti con ispezione

## Plus 1,2 mm

porcellanati in nero opaco,  
nero ultra matt e grigio

Plus matt black, ultra matt black and grey vitreous enamelled  
90° with inspection and 45° with inspection elbows

Coudes émaillés Plus 90° avec trappe de visite et 45°  
avec trappe de visite en noir mat, noir ultra mat et gris

Mattschwarz, ultra mattschwarz und grau emailierte  
Plus Knie mit 90°- und 45°-Winkel und Reinigungsöffnung

		90°		45°	
Øcm	color	cod.	Pack	cod.	Pack
10	N	NNO1008*	1	NNO10048*	1
12	N	NNO1208	1	-	-
12,5	N	NNO12508	1	NNO125048	1
13	N	NNO1308	1	-	-
15	N	NNO1508	1	NNO15048	1
	U	UU1508	1	-	-
	G	GGO1508*	1	-	-
15,3	N	NNO15308	1	-	-
16	N	NNO1608*	1	-	-
18	N	NNO1808	1	NNO18048*	1



\* Disponibile fino ad esaurimento scorte • Available till sold out • Disponible jusqu'à épuisement du stock • Solange vorrat reicht

# Tubi per disassamento

## Plus 1,2 mm

porcellanati in nero opaco

Plus matt black vitreous  
enamelled offset pipes

Tubes émaillés Plus  
en noir mat décalés

Mattschwarz emailierte  
Plus Offset-Rohre

Øcm	color	cod.	Pack
12,5	N	NNO125OFF	1
15	N	NNO15OFF	1



# Tubi a "T" Plus 1,2 mm

porcellanati in nero opaco,  
nero ultra matt e grigio

Plus matt black, ultra matt black and grey vitreous enamelled  
female-female or male-female T-pieces

Tés émaillés Plus femelle-femelle ou mâle-femelle  
en noir mat, noir ultra mat et gris

Mattschwarz, ultra mattschwarz und grau emailierte Plus  
T-Stücke Innengewinde/Innengewinde  
oder Außengewinde/Innengewinde

		F/F		M/F	
Øcm	color	cod.	Pack	cod.	Pack
12	N	NNO1205F	1	-	-
12,5	N	NNO12505F	1	NNO12505M	1
	U	UU12505F	1	UU12505M	1
13	N	NNO1305F	1	-	-
14	N	NNO1405F	1	-	-
15	N	NNO1505F	1	NNO1505M	1
	U	UU1505F	1	UU1505M	1
	G	GGO1505F*	1	-	-
15,3	N	NNO15305F	1	-	-
18	N	NNO1805F	1	NNO1805M*	1
	G	GGO1805F*	1	-	-
20	N	NNO2005F	1	-	-

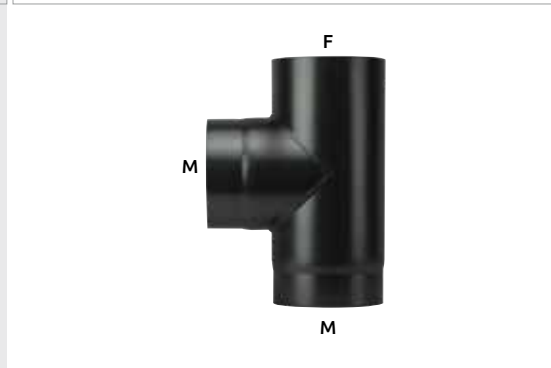

\* Disponibile fino ad esaurimento scorte • Available till sold out • Disponible jusqu'à épuisement du stock • Solange vorrat reicht

# Tappi ciechi per tubi a "T" Plus 1,2 mm

porcellanati in nero opaco,  
nero ultra matt e grigio

Plus matt black, ultra matt black and grey vitreous  
enamelled Blind covers for plus 1.2mm T-pieces  
Tampons borgnes pour tés plus 1,2mm émaillés  
en noir mat, noir ultra mat et gris

Mattschwarz, ultra mattschwarz und grau emailierte  
Blindstopfen für T-Stücke plus 1,2mm

Øcm	color	cod.	Pack
12	N	NNO1219C	1
12,5	N	NNO12519C	1
	U	UU12519C	1
13	N	NNO1319C	1
14	N	NNO1419C	1
15	N	NNO1519C	1
	U	UU1519C	1
	G	GGO1519C *	1
15,3	N	NNO15319C	1
18	N	NNO1819C	1
20	N	NNO2019C	1



Disponibile fino ad esaurimento scorte • Available till sold out • Disponible jusqu'à épuisement du stock • Solange vorrat reicht

# Tubi con serranda H 25cm Plus 1,2 mm

porcellanati in nero opaco

Plus matt black and vitreous enamelled  
pipes with flue damper h. 25 cm

Tubes émaillés Plus en noir mat  
avec registre h 25 cm

Mattschwarz emailierte Plus  
Rohre mit Schieber, h 25 cm

Øcm	color	cod.	Pack
10	N	NNO1006 *	1
12	N	NNO1206	1
12,5	N	NNO12506	1
13	N	NNO1306	1
14	N	NNO1406 *	1
15	N	NNO1506	1
15,3	N	NNO15306 *	1
16	N	NNO1606 *	1
18	N	NNO1806	1



Disponibile fino ad esaurimento scorte • Available till sold out • Disponible jusqu'à épuisement du stock • Solange vorrat reicht

# Raccordi Plus 1,2 mm

porcellanati in nero opaco,  
nero ultra matt e grigio

Plus matt black, ultra matt black and grey vitreous enamelled  
female-female or male-male fittings h. 12cm

Raccords émaillés Plus femelle-femelle ou mâle-mâle  
h 12cm en noir mat, noir ultra mat et gris

Mattschwarz, ultra mattschwarz und grau emailierte Plus  
Anschlussstücke Innengewinde/Innengewinde  
oder Außengewinde/Außengewinde (h12 cm)

		F/F		M/M	
Øcm	color	cod.	Pack	cod.	Pack
10	N	NNO1017F*	2	NNO1017M*	2
12	N	NNO1217F	2	NNO1217M*	2
12,5	N	NNO12517F	2	NNO12517M	2
	U	UU12517F	2	UU12517M	2
13	N	NNO1317F	2	NNO1317M*	2
14	N	NNO1417F*	2	NNO1417M*	2
15	N	NNO1517F	2	NNO1517M	2
	U	UU1517F	2	UU1517M	2
	G	GGO1517F*	2	GGO1517M*	2
15,3	N	NNO15317F*	2	NNO15317M*	2
16	N	NNO1617F*	2	-	-
18	N	NNO1817F	2	NNO1817M*	2
	G	GGO1817F*	2	GGO1817M*	2
20	N	NNO2017F*	2	NNO2017M*	2



\* Disponibile fino ad esaurimento scorte • Available till sold out • Disponible jusqu'à épuisement du stock • Solange vorrat reicht

LINEA WOOD

# Plus LIGHT



Tubi per stufe a legna porcellanati  
Vitreous enamelled pipes for wood stove  
Tubes émaillé pour poêles à bois  
Emaillierte Rohre für Holzofen



DoP N°6 - Plus Light  
www.savefumisteria.it > Download

## GAMMA COLORI COLOR RANGE

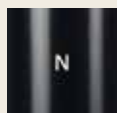

Nero opaco  
Matt black  
Noir mat  
Mattschwarz

## CARATTERISTICHE FEATURES

Questi tubi sono più leggeri ed economici rispetto alla linea Plus 1,2mm, pur mantenendo tutte le caratteristiche normative e prestazionali. Sono perfettamente compatibili sia dal punto di vista tecnico per imbocchi e dimensioni, sia dal punto di vista estetico per l'uguale finitura in smalto porcellanato. Su questi tubi si possono utilizzare gomiti e T della linea Plus 1,2mm oppure gomiti della linea Classic.

Rappresentano il massimo qualitativo della produzione SAVE Spa: tubi in acciaio al carbonio saldati a laser per ottenere saldature perfette, vengono successivamente ricoperti internamente ed esternamente con smalto vetroporcellanato cotto a temperatura di 850°C per conferire eccezionali qualità di resistenza alla corrosione delle condense di combustione.

I risultati del test V2 previsto dalla norma 1856-2 sulla resistenza alla corrosione, hanno dimostrato che i canali da fumo Plus 1.2mm e Plus Light hanno una durata decisamente superiore ai normali tubi verniciati di sp. 2mm non vetrificati internamente.

Resistono perfettamente anche a situazioni estreme come il fuoco di fuliggine (incendio che avviene dentro il tubo) senza rovinarsi o alterarsi.

**La Dichiarazione di Prestazioni (DoP) n°6 Plus Light è disponibile sul sito [www.savefumisteria.it](http://www.savefumisteria.it) alla pagina "download", con tutti i riferimenti ai test eseguiti e le istruzioni di montaggio e manutenzione a garanzia di assoluta sicurezza nell'utilizzo.**

SUL NOSTRO SITO [www.savefumisteria.it](http://www.savefumisteria.it) SONO DISPONIBILI INFORMAZIONI PIÙ DETTAGLIATE SU OGNI SINGOLO PRODOTTO.

These pipes are lighter and less expensive than the Plus 1.2mm line, while maintaining all the characteristics and performance standards. They are fully compatible from both the technical point of view - thanks to the same connections and dimensions - and the aesthetical point of view, thanks to the same enamel coating. These pipes can be fitted with Plus 1.2 mm line elbows and tees or Classic line elbows.

Representing the highest level of SAVE Spa quality, laser-welding ensures these carbon steel pipes perfect welding. Subsequent internal/external vitreous enamel coating baked to 850°C provides exceptional resistance against corrosion by combustion condensate.

V2 test results specified by corrosion resistance Standard 1856-2 show that Plus 1.2 mm and Plus Light flue pipes have a significantly longer duration than normally painted 2 mm thick pipes that have not received internal vitreous enamel coating.

They are perfectly resistant even to extreme situations such as soot-fire (a fire that occurs inside the pipe) without being damaged or modified.

**The Declaration of Performance (DoP) n°6 Plus Light is available at [www.savefumisteria.it](http://www.savefumisteria.it) in the download area, with reference to all the tests performed and Installation and Maintenance Instructions to ensure the greatest safety during use.**

MORE DETAILED INFORMATION ABOUT EACH PRODUCTS ARE AVAILABLE ON OUR WEBSITE [www.savefumisteria.it](http://www.savefumisteria.it)

## ANTICONDENSA ANTI-CONDENSATE

Per evitare la fuoriuscita di condensa è necessario che vengano montati con l'imbocco rivolto verso il basso (vedi disegno). Per fare questo può essere necessario usare come partenza il raccordo F/F anticondensa.

In order to prevent the leakage of condensate, they must be fitted with the inlet facing downwards (see drawing). To do this, it may be necessary to use an F/F anti-condensate fitting to start with.

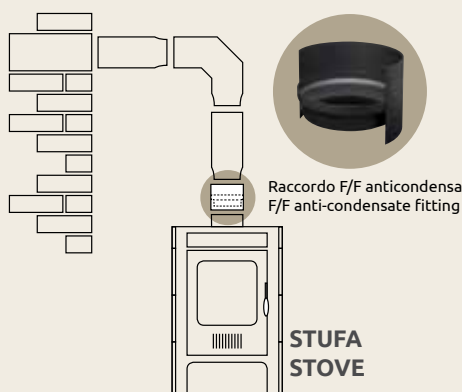

## DESIGNAZIONI DESIGNATION

- Ⓒ EN 1856-2 – T600 – N1 – W – V2 – L80070 – G600NM
- Ⓒ EN 1856-2 – T600 – N1 – W – V2 – L80070 – O600
- Ⓒ EN 1856-2 – T450 – N1 – W – V2 – L80070 – G600NM
- Ⓒ EN 1856-2 – T450 – N1 – W – V2 – L80070 – O450

# Tubi Plus **LIGHT**

porcellanati in nero opaco

Plus Light matt black vitreous enamelled pipes

Tubes émaillés Plus Light en noir mat

Mattschwarz emailierte Plus Rohre

Øcm	color	L 100cm		L 50cm		L 25cm	
		cod.	Pack	cod.	Pack	cod.	Pack
12	N	NNOL1200	6	NNOL1201	6	NNOL1202	6
12,5	N	NNOL12500	6	NNOL12501	6	NNOL12502	6
13	N	NNOL1300	6	NNOL1301	6	NNOL1302	6
14	N	NNOL1400	6	NNOL1401	6	NNOL1402	6
15	N	NNOL1500	6	NNOL1501	6	NNOL1502	6
15,3	N	NNOL15300	6	NNOL15301	6	NNOL15302	6



# Tubi telescopici H50cm e H33cm Plus **LIGHT**

porcellanati in nero opaco

Plus Light matt black vitreous enamelled telescopic pipes h. 50 cm and h. 33 cm

Tubes émaillés télescopiques Plus h 50 cm et h 33 cm en noir mat

Ausziehbare emailierte Plus Rohre (h 50 cm und h 33 cm) in mattschwarz

Øcm	color	H 50cm		H 33cm	
		cod.	Pack	cod.	Pack
12,5	N	NNOL12521*	1	NNOL12520*	1
15	N	NNOL1521*	1	NNOL1520*	1
15,3	N	NNOL15321*	1	NNOL15320*	1

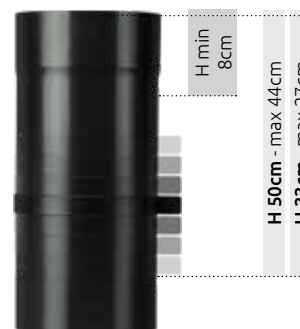

Disponibile fino ad esaurimento scorte • Available till sold out • Disponible jusqu'à épuisement du stock • Solange vorrat reicht

# Gomiti Plus 1,2 mm

porcellanati in nero opaco

Plus matt black vitreous enamelled  
90°, 45°, 30° and 15° elbows

Coudes émaillés Plus  
90°, 45°, 30° et 15° en noir mat

Mattschwarz emailierte Plus Knie  
mit 90°-, 45°-, 30°-, 15°-Winkel

100% compatible with

**Plus LIGHT**

		90°		45°		30°		15°	
Øcm	color	cod.	Pack	cod.	Pack	cod.	Pack	cod.	Pack
12	N	NNO1203	4	NNO1204	4	-	-	-	-
12,5	N	NNO12503	4	NNO12504	4	NNO12543	4	NNO12544	4
13	N	NNO1303	4	NNO1304	4	-	-	-	-
14	N	NNO1403	4	NNO1404	4	-	-	-	-
15	N	NNO1503	4	NNO1504	4	NNO1543	4	NNO1544	4
15,3	N	NNO15303	4	NNO15304	4	-	-	-	-



# Gomiti con ispezione Plus 1,2 mm

porcellanati in nero opaco

Plus matt black vitreous enamelled  
90° with inspection and 45° with  
inspection elbows

Coudes émaillés Plus  
90° avec trappe de visite et  
45° avec trappe de visite en noir mat

Mattschwarz emailierte Plus Knie  
mit 90°- und 45°-Winkel und Reinigungsöffnung

100% compatible with

**Plus LIGHT**

		90°		45°	
Øcm	color	cod.	Pack	cod.	Pack
12	N	NNO1208	1	-	-
12,5	N	NNO12508	1	NNO125048	1
13	N	NNO1308	1	-	-
15	N	NNO1508	1	NNO15048	1
15,3	N	NNO15308	1	-	-





# Tubi a "T" Plus 1,2 mm

porcellanati in nero opaco

Plus matt black vitreous enamelled  
female-female or male-female T-pieces

Tés émaillés Plus femelle-femelle  
ou mâle-femelle en noir mat

Mattschwarz emailierte Plus  
T-Stücke Innengewinde/Innengewinde  
oder Außengewinde/Innengewinde

100% compatible with

Plus LIGHT

F/F				M/F	
Øcm	color	cod.	Pack	cod.	Pack
12	N	NNO1205F	1	-	-
12,5	N	NNO12505F	1	NNO12505M	1
13	N	NNO1305F	1	-	-
14	N	NNO1405F	1	-	-
15	N	NNO1505F	1	NNO1505M	1
15,3	N	NNO15305F	1	-	-



# Tappi ciechi per tubi a "T" Plus 1,2 mm

porcellanati in nero opaco

Plus matt black vitreous enamelled  
Blind covers for Plus 1.2mm T-pieces

Tampons borgnes pour tés Plus 1,2mm  
émaillés en noir mat

Mattschwarz emailierte Blindstopfen  
für T-Stücke Plus 1,2mm

100% compatible with

Plus LIGHT

Øcm	color	cod.	Pack
12	N	NNO1219C	1
12,5	N	NNO12519C	1
13	N	NNO1319C	1
14	N	NNO1419C	1
15	N	NNO1519C	1
15,3	N	NNO15319C	1



# Tubi con serranda

## H 25cm Plus 1,2 mm

porcellanati in nero opaco

Plus matt black and vitreous enamelled pipes with flue damper h. 25 cm

Tubes émaillés Plus en noir mat avec registre h 25 cm

Mattschwarz emaillierte Plus  
Rohre mit Schieber, h 25 cm

100% compatible with

Plus LIGHT

Øcm	color	cod.	Pack
12	N	NNO1206	1
12,5	N	NNO12506	1
13	N	NNO1306	1
14	N	NNO1406*	1
15	N	NNO1506	1
15,3	N	NNO15306*	1



Disponibile fino ad esaurimento scorte • Available till sold out • Disponible jusqu'à épuisement du stock • Solange vorrat reicht

# Raccordi

## Plus 1,2 mm

porcellanati in nero opaco

Plus matt black vitreous enamelled female-female or male-male fittings h.12cm

Raccords émaillés Plus femelle-femelle ou mâle-mâle h 12cm en noir mat

Mattschwarz emaillierte Plus  
Anschlussstücke Innengewinde/Innengewinde oder Außengewinde/Außengewinde (h12 cm)

100% compatible with

Plus LIGHT

Øcm	color	cod.	Pack	F/F		M/M	
				cod.	Pack	cod.	Pack
12	N	NNO1217F	2	NNO1217M*	2		
12,5	N	NNO12517F	2	NNO12517M	2		
13	N	NNO1317F	2	NNO1317M*	2		
14	N	NNO1417F*	2	NNO1417M*	2		
15	N	NNO1517F	2	NNO1517M	2		
15,3	N	NNO15317F*	2	NNO15317M*	2		



Disponibile fino ad esaurimento scorte • Available till sold out • Disponible jusqu'à épuisement du stock • Solange vorrat reicht

LINEA WOOD

# Accessori Plus & Plus **LIGHT**

Accessori "PLUS & PLUS LIGHT" in nero opaco, nero ultra matt e grigio  
Matt black, ultra matt black and grey "PELLET" accessories  
Accessoires "PELLET" en noir mat, noir ultra mat et gris  
Accessoires Baureihe "PELLET" in mattschwarz, ultra mattschwarz und grau

## GAMMA COLORI COLOR RANGE

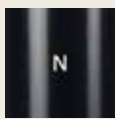

**N**  
Nero opaco  
Matt black  
Noir mat  
Mattschwarz



**U**  
Nero ultra matt  
Ultramatt black  
Noir ultramat  
Schwarz ultramatt



**G**  
Grigio  
Grey  
Gris  
Grau

### ATTENZIONE:

Tutti gli accessori verniciati sono compatibili con le finiture smaltate nero opaco e nero ultra matt.

### ATTENTION:

All black painted accessories are compatible with vitreous enamelled finishes in matt black and ultra matt black.

### AVERTISSEMENT:

Tous les accessoires en peinture noir sont compatibles avec les finitions en emaille noir matt et noir ultra matt.

### ACHTUNG:

Alle schwarz lackierte Zubehöre sind kompatibel mit emallierte Rohre in mattschwarz und ultra mattschwarz.

## CARATTERISTICHE FEATURES

Tutti gli Accessori Plus SAVE sono appositamente studiati per essere perfettamente adattabili alle linee Pellet, Pellet Light, Plus 1,2mm, Plus Light.

All the Plus SAVE accessories have been specifically designed to fit the Pellet, Pellet Light, Plus 1,2mm, Plus Light.

SUL NOSTRO SITO [www.savefumisteria.it](http://www.savefumisteria.it) SONO DISPONIBILI INFORMAZIONI PIÙ DETTAGLIATE SU OGNI SINGOLO PRODOTTO.

MORE DETAILED INFORMATION ABOUT EACH PRODUCTS ARE AVAILABLE ON OUR WEBSITE [www.savefumisteria.it](http://www.savefumisteria.it)

Pellet

Pellet

Pellet  
**LIGHT**

Accessori  
Pellet

Wood

Plus  
1,2mm

Plus  
**LIGHT**

Accessori  
Plus

Plus &amp; Plus Light

# Anelli Plus

verniciati in nero opaco e grigio

Matt black and grey painted Plus ring

Anneaux Plus laqués noir mat e gris

Mattschwarz und grau lackierte Plus Ringe

90°				45°	
Øcm	color	cod.	Pack	cod.	Pack
10	N	NN1010	10	-	-
12	N	NN1210	10	-	-
12,5	N	NN12510	10	NN12514	10
13	N	NN1310	10	-	-
14	N	NN1410	10	-	-
15 / 15,3	N	NN1510	10	NN1514	10
	G	GG1510*	10	-	-
16	N	NN1610	10	-	-
18	N	NN1810	10	-	-
20	N	NN2010	10	-	-



Disponibile fino ad esaurimento scorte • Available till sold out • Disponible jusqu'à épuisement du stock • Solange vorrat reicht

Plus &amp; Plus Light

## Kit fissaggio magnetico per anelli

Magnetic fixing kit for rings

Magnetic kit de montage pour les anneaux

Magnetischer Montage-Kit für Ringe

cod.	Pack
NNFIX	20



Plus & Plus Light

## Rosoni Plus

verniciati in nero opaco e grigio

Matt black and grey painted Plus covers

Rosaces Plus laqués noir mat e gris

Mattschwarz und grau lackierte Plus Rosetten

Øcm	color	cod.	Pack
12	N	NN1209	5
13	N	NN1309	5
14	N	NN1409	5
15	N	NN1509	5
16	N	NN1609*	5
18	N	NN1809*	5
20	N	NN2009*	5



Disponibile fino ad esaurimento scorte • Available till sold out • Disponible jusqu'à épuisement du stock • Solange vorrat reicht

Plus & Plus Light

## Reggitubo Plus

verniciati in nero opaco e grigio

Matt black and grey painted stainless steel Plus pipe holder

Porte-tubes Plus laqué noir mat et gris

Mattschwarz und grau lackierter Plus Rohrhalter mit Dübel

Øcm	color	cod.	Pack
10	N	NN210	10
12	N	NN212	10
13 / 12,5	N	NN213	10
14	N	NN214	10
15 / 15,3	N	NN215	10
	G	GG215*	10
16	N	NN216	10
18	N	NN218	10
	G	GG218*	10
20	N	NN220	10



Disponibile fino ad esaurimento scorte • Available till sold out • Disponible jusqu'à épuisement du stock • Solange vorrat reicht

Plus &amp; Plus Light

# Riduzioni Plus

porcellanate in nero opaco e grigio

Matt black and grey vitreous enamelled Plus reducers

Réductions Plus émaillés noir mat et gris

Mattschwarz und grau emailierte Plus Reduzierstücke

Øcm	color	cod.	Pack
20F / 18M	N	NNO20F/18M	2
20F / 15M	N	NNO20F/15M	2
18F / 15M	N	NNO18F/15M	2
16F / 15M	N	NNO16F/15M	2
15,3F / 15M	N	NNO153F/15M	2
15F / 14M	N	NNO15F/14M	2
15F / 13M	N	NNO15F/13M	2
15F / 12,5M	N	NNO15F/125M	2
15F / 12M	N	NNO15F/12M	2
14F / 13M	N	NNO14F/13M	2
14F / 12M	N	NNO14F/12M*	2
13F / 12M	N	NNO13F/12M	2
12,5F / 13M	N	NNO125F/13M*	2



\* Disponibile fino ad esaurimento scorte • Available till sold out • Disponible jusqu'à épuisement du stock • Solange vorrat reicht

Plus &amp; Plus Light

# Raccordi telescopici a soffitto Plus

verniciati in nero opaco

Plus matt black painted  
telescopic ceiling fittingsRaccords télescopiques Plus  
plafond laqués noir matAusziehbares Plus  
Deckenanschlussstück,  
mattschwarz lackiert

Øcm	color	cod.	Pack
15	N	NN1511	1



Plus & Plus Light

## Raccordi F/F anticondensa Plus

porcellanati in nero opaco,  
nero ultra matt e grigio

Matt black, ultra matt black and grey vitreous enamelled Plus  
female-female anti-condensate fittings

Raccords anticondensation Plus femelle-femelle émaillés  
en noir mat, noir ultra mat et gris

Anschlussstücke mit Kondensationsschutz Plus,  
Innengewinde/Innengewinde, mattschwarz,  
ultra mattschwarz und grau emaillierte

Øcm	color	cod.	Pack
12	N	NNO1231	2
12,5	N	NNO12531	2
	U	UU12531	2
13	N	NNO1331	2
14	N	NNO1431	2
15	N	NNO1531	2
	U	UU1531	2
15,3	N	NNO15331	2
18	N	NNO1831	2
20	N	NNO2031	2



Plus & Plus Light

## Serrande Plus

verniciate in nero opaco e grigio

Plus matt black and grey painted flue damper

Registre Plus laqué noir mat et gris

Plus Schieber, mattschwarz und grau lackiert

Øcm	color	cod.	Pack
12-13	N	NN12/1315	1
14 - 15 - 16	N	NN14/15/1615	1
	G	GG14/15/1615*	1
18-20	N	NN18/2015	1



Disponibile fino ad esaurimento scorte • Available till sold out • Disponible jusqu'à épuisement du stock • Solange vorrat reicht

## Pedane

in acciaio verniciato nero opaco  
e vetro temperato

Matt black painted steel  
and toughened glass bases

Bases en acier laqué noir mat  
et verre trempé

Bodenplatten aus mattschwarz  
lackiertem Stahl und Sekuritglas

	100x90cm		90x80cm		80x60cm		70x60cm	
color	cod.	Pack	cod.	Pack	cod.	Pack	cod.	Pack
N	P100/90*	1	P90/80*	1	P80/60*	1	P70/60*	1
G	-	-	-	-	PV80/60*	1	-	-



Disponibile fino ad esaurimento scorte • Available till sold out • Disponible jusqu'à épuisement du stock • Solange vorrat reicht

## Bombolette spray per ritocchi

colore nero opaco e grigio

Spray canisters for touch-ups  
(matt black and grey)

Vaporisateurs pour retouches  
(noir mat et gris)

Spraydosen zum Nachbessern  
(mattschwarz und grau)

color	cod.	Pack
N	NNSPRAY	1
G	GGSPRAY*	1



Disponibile fino ad esaurimento scorte • Available till sold out • Disponible jusqu'à épuisement du stock • Solange vorrat reicht

## Coppelle di coibentazione

in lana di roccia  
(lunghezza 1mt - spessore 30mm)

Rock wool pipe insulators  
(1mt long - 30 mm thick)

Couppelles d'isolement en laine de roche  
(longueur 1mt - épaisseur 30 mm)

Dämmmantel - Steinwolle  
(Länge 1 m - Stärke 30 mm)

Øcm	cod.	Pack
8	AA815	10
10	AA1015	8
12	AA1215	7
13	AA1315	7
14	AA1415*	7
15	AA1515	7



Disponibile fino ad esaurimento scorte • Available till sold out • Disponible jusqu'à épuisement du stock • Solange vorrat reicht



LINEA WOOD

# Classic

Tubi porcellanati Classic in bianco, marrone e nero opaco  
Classic white, brown and matt black vitreous enamelled pipes  
Tubes émaillés Classic en blanc, marron et noir mat  
Weiß, braun und mattschwarz emaillierte Classic Rohre



## GAMMA COLORI COLOR RANGE



Bianco  
White  
Blanc  
Weiss

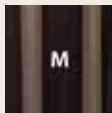

Marrone  
Brown  
Marron  
Braun

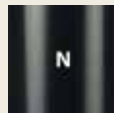

Nero opaco  
Matt black  
Noir mat  
Mattschwarz

## CARATTERISTICHE FEATURES

I tubi smaltati SAVE sono prodotti con lamiera di acciaio rivestita con smalto porcellanato tramite un procedimento che prevede la cottura del pezzo a ben 830°C.

Lo smalto porcellanato rende questo tubo preferibile ad ogni altro per alcune caratteristiche:

- resistenza alle più alte temperature di esercizio: T600, la classe più alta secondo la EN 1856-2
- resistenza allo sbalzo termico
- resistenza alla corrosione da condensa certificata dal superamento del test V2 che li rende idonei all'utilizzo con qualsiasi tipo di combustibile: solido, liquido e gassoso
- resistenza all'abrasione e agli agenti chimici: sono lavabili con qualsiasi solvente o prodotto per la pulizia.
- tenuta ai gas della combustione (tiraggio naturale)
- qualità estetica: i colori non si alterano con l'uso o con le alte temperature

La Dichiarazione di Prestazioni (DoP) n°1 Classic è disponibile sul sito [www.savefumisteria.it](http://www.savefumisteria.it) alla pagina "download", con tutti i riferimenti ai test eseguiti e le istruzioni di montaggio e manutenzione a garanzia di assoluta sicurezza nell'utilizzo.

SUL NOSTRO SITO [www.savefumisteria.it](http://www.savefumisteria.it) SONO DISPONIBILI INFORMAZIONI PIÙ DETTAGLIATE SU OGNI SINGOLO PRODOTTO.

The SAVE vitreous enamelled pipes are made of sheet steel coated with vitreous enamel and baked at 830°C.

The vitreous enamel coating makes this pipe better than any other pipe thanks to some of its features:

- resistance to the highest working temperatures: T600, the highest class according to EN 1856-2
- resistance to any changes in temperature
- resistance to condensate corrosion certified by the outcome of the V2 test for qualification for use with any type of solid, liquid or gas fuel.
- resistance to abrasion and chemical agents; they can be cleaned with any solvent or cleaning product
- combustion gas-tight (natural draught)
- aesthetic quality: colours do not alter with use or as a result of high temperatures

The Declaration of Performance (DoP) n°1 Classic is available at [www.savefumisteria.it](http://www.savefumisteria.it) in the download area, with reference to all the tests performed and Installation and Maintenance Instructions to ensure the greatest safety during use.

MORE DETAILED INFORMATION ABOUT EACH PRODUCTS ARE AVAILABLE ON OUR WEBSITE [www.savefumisteria.it](http://www.savefumisteria.it)

## CAMPO DI APPLICAZIONE FIELD OF APPLICATION

APPARECCHI E STUFE A:

- Legna
- Carbone
- Gas
- Gasolio
- Kerosene

APPLIANCES AND STOVES:

- Wood-burning
- Coal
- Gas
- Gas oil
- Kerosene

## DESIGNAZIONI DESIGNATION

⊕ EN 1856-2 – T600 – N1 – D – V2 – L80055 – G450NM

⊕ EN 1856-2 – T600 – N1 – D – V2 – L80055 – O450

⊕ EN 1856-2 – T450 – N1 – D – V2 – L80055 – G450NM

⊕ EN 1856-2 – T450 – N1 – D – V2 – L80055 – O350

Pellet

Pellet

Pellet  
LIGHT

Accessori  
Pellet

Wood

Plus  
1,2mm

Plus  
LIGHT

Accessori  
Plus

Classic

# Tubi Classic

porcellanati in bianco,  
marrone e nero opaco

Classic white, brown and matt black  
vitreous enamelled pipes

Tubes émaillés Classic  
en blanc, marron et noir mat

Weiß, braun und Mattschwarz  
emailierte Classic Rohre

Øcm	color	L 100cm		L 50cm		L 25cm	
		cod.	Pack	cod.	Pack	cod.	Pack
8	B	B800	12	B801	12	B802	12
	M	M800	12	M801	12	M802	12
9	B	B900	12	B901	12	B902	12
10	B	B1000	12	B1001	12	B1002	12
	M	M1000	12	M1001	12	M1002	12
	N	NO1000	12	NO1001	12	NO1002	12
11	B	B1100*	12	B1101*	12	B1102*	12
	M	M1100*	12	M1101*	12	M1102*	12
12	B	B1200	12	B1201	12	B1202	12
	M	M1200	12	M1201	12	M1202	12
	N	NO1200	12	NO1201	12	NO1202	12
13	B	B1300	12	B1301	12	B1302	12
	M	M1300	12	M1301	12	M1302	12
	N	NO1300	12	NO1301	12	NO1302	12
14	B	B1400	6	B1401	6	B1402	6
	M	M1400	6	M1401	6	M1402	6
	N	NO1400	6	NO1401	6	NO1402	6
15	B	B1500	6	B1501	6	B1502	6
	M	M1500	6	M1501	6	M1502	6
	N	NO1500	6	NO1501	6	NO1502	6



\* Disponibile fino ad esaurimento scorte • Available till sold out • Disponible jusqu'à épuisement du stock • Solange vorrat reicht



# Gomiti Classic

porcellanati in bianco,  
marrone e nero opaco

Classic white, brown and matt black  
vitreous enamelled 90° and 45° elbows

Coudes émaillés Classic 90° et 45°  
en blanc, marron et noir mat

Weiß, braun und Mattschwarz  
emailierte Classic 90°- und 45°-Knie

		90°		45°	
Øcm	color	cod.	Pack	cod.	Pack
8	B	B803	12	B804	12
	M	M803	12	M804	12
9	B	B903	12	-	-
10	B	B1003	12	B1004	12
	M	M1003	12	M1004	12
	N	NO1003	12	NO1004	12
12	B	B1203	12	B1204	12
	M	M1203	12	M1204	12
	N	NO1203	12	NO1204	12
13	B	B1303	12	B1304	12
	M	M1303	12	M1304	12
	N	NO1303	12	NO1304	12
14	B	B1403	6	B1404	6
	M	M1403	6	M1404	6
	N	NO1403	6	NO1404	6
15	B	B1503	6	B1504	6
	M	M1503	6	M1504	6
	N	NO1503	6	NO1504	6



# Tubi H 25cm con foro per serranda Classic

porcellanati in bianco, marrone e nero opaco

Classic white, brown and matt black vitreous enamelled drilled pipes for flue dampers (h= 25 cm)

Tubes Classic ayant un trou pour le registre (h=25 cm) en blanc, marron et noir mat

Emallierte Classic Rohre mit Öffnung für Schieber (H=25 cm) in weiß, braun und mattschwarz

Øcm	color	cod.	Pack
10	B	B1006*	12
12	B	B1206*	12
	M	M1206	12
	N	NO1206*	12



Disponibile fino ad esaurimento scorte • Available till sold out • Disponible jusqu'à épuisement du stock • Solange vorrat reicht

## Serrande

zincate

Galvanised flue dampers

Registres galvanisé

Verzinkte Schieber

Øcm	color	cod.	Pack
10	Z	Z1015*	1
11	Z	Z1115*	1
12	Z	Z1215	1
13	Z	Z1315*	1
16	Z	Z1615*	1



Disponibile fino ad esaurimento scorte • Available till sold out • Disponible jusqu'à épuisement du stock • Solange vorrat reicht

# Rosoni Master Euroflues

verniciati in bianco, marrone,  
nero e alluminati

Euroflues Master covers painted in white,  
brown, black and aluminized steel

Rosaces Master Euroflues laquées blanc,  
marron, noir et en acier aluminatée

Weiß, braun, Schwarz lackierte und  
Aluminatstahl Master Euroflues Rosetten

Øcm	color	cod.	Pack
8	B	EB809	10
	M	EM809	10
	N	EN809	10
	A	EA809	10
9	B	EB909	10
	A	EA909	10
10	B	EB1009	10
	M	EM1009	10
	N	EN1009	10
	A	EA1009	10
11	B	EB1109	10
	A	EA1109	10
12	B	EB1209	10
	M	EM1209	10
	N	EN1209	10
	A	EA1209	10
13	B	EB1309	10
	M	EM1309	10
	N	EN1309	10
	A	EA1309	10
14	B	EB1409	10
	M	EM1409	10
	N	EN1409	10
	A	EA1409	10
15	B	EB1509	10
	M	EM1509	10
	N	EN1509	10
	A	EA1509	10
16	B	EB1609	10
	A	EA1609	10
18	B	EB1809	10
	A	EA1809	10
20	B	EB2009	10
	A	EA2009	10



# Riduzioni Master Euroflues

verniciate in bianco, marrone,  
nero opaco e alluminio

Euroflues Master white, brown, matt black  
painted and aluminium reducers

Réductions Master Euroflues laquées blanc,  
marron, noir mat et en aluminium

Weiß, braun, mattschwarz lackierte und  
Aluminium Master Euroflues reduzierstücke

Øcm	color	cod.	Pack
9F / 8M	B	EB9F/8M	10
	M	EM9F/8M	10
10F / 8M	B	EB10F/8M	10
	M	EM10F/8M	10
	N	ENO10F/8M	10
10F / 9M	B	EB10F/9M	10
11F / 8M	B	EB11F/8M*	10
	M	EM11F/8M*	10
11F / 9M	B	EB11F/9M	10
11F / 10M	B	EB11F/10M	10
	M	EM11F/10M	10
12F / 8M	B	EB12F/8M	10
	M	EM12F/8M	10
	N	ENO12F/8M	10
	A	EA12F/8M*	10
12F / 9M	B	EB12F/9M	10
	M	EM12F/9M*	10
	A	EA12F/9M*	10
12F / 10M	B	EB12F/10M	10
	M	EM12F/10M	10
	N	ENO12F/10M	10
	A	EA12F/10M	10
12F / 11M	B	EB12F/11M	10
	M	EM12F/11M	10
	N	ENO12F/11M	10
	A	EA12F/11M*	10
13F / 8M	B	EB13F/8M	10
	A	EA13F/8M*	10
13F / 9M	B	EB13F/9M*	10
13F / 10M	B	EB13F/10M	10
	M	EM13F/10M	10
	N	ENO13F/10M	10

Øcm	color	cod.	Pack
13F / 11M	B	EB13F/11M	10
	M	EM13F/11M*	10
13F / 12M	B	EB13F/12M	10
	M	EM13F/12M	10
	N	ENO13F/12M	10
	A	EA13F/12M	10
14F / 8M	B	EB14F/8M	10
14F / 10M	B	EB14F/10M	10
	N	ENO14F/10M*	10
	A	EA14F/10M*	10
14F / 11M	B	EB14F/11M	10
	M	EM14F/11M*	10
	A	EA14F/11M*	10
14F / 12M	B	EB14F/12M	10
	M	EM14F/12M	10
	N	ENO14F/12M	10
	A	EA14F/12M	10
14F / 13M	B	EB14F/13M	10
	M	EM14F/13M	10
	N	ENO14F/13M	10
	A	EA14F/13M*	10
15F / 12M	B	EB15F/12M	10
	M	EM15F/12M	10
	N	ENO15F/12M	10
	A	EA15F/12M	10
15F / 13M	B	EB15F/13M	10
	N	ENO15F/13M	10
	A	EA15F/13M	10
15F / 14M	B	EB15F/14M	10
	N	ENO15F/14M	10
	A	EA15F/14M	10

Øcm	color	cod.	Pack
<b>16F / 14M</b>	B	EB16F/14M*	10
	M	EM16F/14M*	10
	N	ENO16F/14M*	10
	A	EA16F/14M*	10
<b>16F / 15M</b>	B	EB16F/15M*	10
	M	EM16F/15M*	10
	N	ENO16F/15M*	10
<b>18F / 15M</b>	A	EA18F/15M*	10
<b>18F / 16M</b>	B	EB18F/16M*	10
	M	EM18F/16M*	10
<b>20F / 18M</b>	B	EB20F/18M*	10
	M	EM20F/18M*	10

Øcm	color	cod.	Pack
<b>8F / 10M</b>	B	EB8F/10M	10
	M	EM8F/10M	10
	N	ENO8F/10M	10
<b>8F / 12M</b>	B	EB8F/12M	10
	M	EM8F/12M	10
	N	ENO8F/12M	10
<b>10F / 12M</b>	B	EB10F/12M	10
	M	EM10F/12M	10
	N	ENO10F/12M	10
<b>11F / 12M</b>	B	EB11F/12M	10



\* Disponibile fino ad esaurimento scorte • Available till sold out • Disponible jusqu'à épuisement du stock • Solange vorrat reicht

# Reggitubo Classic

verniciati in bianco,  
marrone e nero

Classic white, brown and black  
painted pipe holder

Porte-tubes à cheville Classic  
laqué blanc, marron et noir

Lackierter Classic Rohrhalter mit Dübel  
in weiß, braun und schwarz

Øcm	color	cod.	Pack
8 / 13	N	N28/13*	5
10 / 15	B	B210/15	5
	M	M210/15	5
	N	N210/15*	5



Disponibile fino ad esaurimento scorte • Available till sold out • Disponible jusqu'à épuisement du stock • Solange vorrat reicht

# Stendibiancheria Classic

verniciati in bianco  
e marrone

Classic white and brown  
clothes drier

Séchoir à linge Classic  
en blanc et marron

Classic Wäschetrockner  
in weiß und braun

Øcm	color	cod.	Pack
8 / 14	B	B5	6
	M	M5*	6

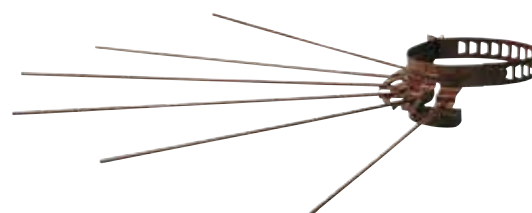

Disponibile fino ad esaurimento scorte • Available till sold out • Disponible jusqu'à épuisement du stock • Solange vorrat reicht





LINEA  
**Air**

**Tubi zincati e  
tubi flessibili in alluminio**

**Galvanised sheet iron pipes  
and Aluminium flexible pipes**



LINEA AIR

# Zincato

Tubi e gomiti zincati  
Galvanised sheet iron pipes and elbows  
Tubes et coudes en tôle galvanisée  
Rohre und Knie aus verzinktem Blech

## GAMMA COLORI COLOR RANGE

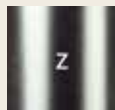

Zincato  
Galvanised  
Galvanisée  
Verzinkt

SUL NOSTRO SITO [www.savefumisteria.it](http://www.savefumisteria.it) SONO DISPONIBILI INFORMAZIONI PIÙ DETTAGLIATE SU OGNI SINGOLO PRODOTTO.

MORE DETAILED INFORMATION ABOUT EACH PRODUCTS ARE AVAILABLE ON OUR WEBSITE [www.savefumisteria.it](http://www.savefumisteria.it)

## Tubi zincati

Galvanised sheet iron pipes  
Tubes en tôle galvanisée  
Rohre aus verzinktem Blech

L 100cm

Øcm	color	cod.	Pack
8	Z	Z800	12
10	Z	Z1000	12
12	Z	Z1200	12
13	Z	Z1300	12
14	Z	Z1400	6
15	Z	Z1500	6
16	Z	Z1600	6
18	Z	Z1800	4
20	Z	Z2000	4



## Gomiti

zincati

Galvanised sheet iron 90° elbows

Coudes 90° en tôle galvanisée

90°-Knie aus verzinktem Blech

90°			
Øcm	color	cod.	Pack
8	Z	Z803	12
10	Z	Z1003	12
12	Z	Z1203	12
13	Z	Z1303	12
14	Z	Z1403	6
15	Z	Z1503	6
16	Z	Z1603	8
18	Z	Z1803	8
20	Z	Z2003	8



## Fumaioli

zincati

Galvanised smoke stacks

Cheminées galvanisées

Verzinkte Schornsteine

Øcm	color	cod.	Pack
8	Z	Z812	4
10	Z	Z1012	4
12	Z	Z1212	4
13	Z	Z1312	4
14	Z	Z1412	4
15	Z	Z1512	4
16	Z	Z1612	4
18	Z	Z1812	4
20	Z	Z2012	4



## Tubi ad "H"

zincati

Galvanised H-pieces

Tubes galvanisés en forme de H

Verzinkte H-Stücke

Øcm	color	cod.	Pack
12	Z	Z1208	6



LINEA AIR

# Flessibili alluminio



Tubi flessibili in alluminio naturale o verniciati bianchi

Aluminium flexible pipes in natural aluminium or white painted aluminium

Tubes flexibles en aluminium avec bouche en aluminium naturel ou laqué blanc

Classic Aluminium-Flexrohre mit Abschrägung in Aluminium natur oder weiß gefärbtem Aluminium

## GAMMA COLORI COLOR RANGE

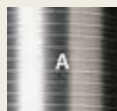

Alluminio naturale  
Natural aluminium  
Aluminium naturel  
Aluminium natur



Bianco  
White  
Blanc  
Weiss

## CARATTERISTICHE FEATURES

**E' un tubo di grande praticità e facilità d'installazione, elimina i gomiti e si adatta alle varie lunghezze che l'installazione richiede: un pezzo di 85 cm si può allungare fino a 3 metri!**

TEMPERATURA MASSIMA DI ESERCIZIO:

- 300°C per il tubo in alluminio naturale
- 200°C per il tubo in alluminio colorato (in questo caso è la vernice che si deteriora).

Il tubo flessibile in alluminio non si può usare su stufe a legna e carbone perchè i loro fumi normalmente raggiungono temperature superiori ai 300°C.

SUL NOSTRO SITO [www.savefumisteria.it](http://www.savefumisteria.it) SONO DISPONIBILI INFORMAZIONI PIÙ DETTAGLIATE SU OGNI SINGOLO PRODOTTO.

This pipe is extremely practical to use and easy to install. It eliminates the need for elbows and adapts to a variety of lengths to suit specific installation requirements: an 85 cm piece can extend up to 3 metres!

MAXIMUM OPERATING TEMPERATURE:

- 300°C for the natural aluminium pipe
- 200°C for the painted aluminium pipe (in this case it is the paint that deteriorates).

The flexible aluminium pipe cannot be used on wood-burning and coal stoves as the temperature of the smoke produced normally exceeds 300°C.

MORE DETAILED INFORMATION ABOUT EACH PRODUCTS ARE AVAILABLE ON OUR WEBSITE [www.savefumisteria.it](http://www.savefumisteria.it)

## CAMPO DI APPLICAZIONE FIELD OF APPLICATION

- CONDOTTE D'ARIA
- ASPIRAZIONI
- CAPPE

- AIR DUCTS
- SUCTION SYSTEMS
- HOODS

# Tubi flessibili con invito (sp. 0,12mm)

in alluminio naturale o verniciato bianco

Flexible aluminium pipes with inlet in natural aluminium and white painted aluminium (THK. 0.12 mm)

Tubes flexibles en aluminium avec bouche, en aluminium naturel et aluminium laqué blanc (EP.=0,12 mm)

Aluminium-Flexrohre mit Abschrägung in Aluminium natur und weiß gefärbtem Aluminium (Stärke 0,12 mm)

I prezzi si intendono al pezzo di 85cm allungabile fino a 300cm.

ALLUMINIO NATURALE:  
Temperatura max. 300°  
ALLUMINIO VERNICIATO:  
Temperatura max. 200°

Prices are per 85 cm piece extendable to 300 cm.

NATURAL ALUMINIUM:  
Max. operating temperature 300°C.  
PAINTED ALUMINIUM:  
Max. operating temperature 200°C.

Les prix s'entendent par pièce de 85 cm extensible jusqu'à 300 cm.

ALUMINIUM NATUREL:  
Température max. d'emploi 300°C  
ALUMINIUM LAQUÉ:  
Température max. d'emploi 200°C.

Die Preise verstehen sich je Stück von 85 cm, verlängerbar bis 300 cm.

ALUMINIUM NATUR:  
Maximale Betriebstemperatur 300°C.  
LACKIERTES ALUMINIUM:  
Maximale Betriebstemperatur 200°C.

Øcm	color	cod.	Pack
8	A	FN824	6
	B	FB824	6
9	A	FN924	6
	B	FB924*	6
10	A	FN1024	6
	B	FB1024	6
11	A	FN1124	6
	B	FB1124	6
12	A	FN1224	6
	B	FB1224	6
13	A	FN1324	6
	B	FB1324	6
14	A	FN1424	6
15	A	FN1524	6
16	A	FN1624	6
18	A	FN1824	4
20	A	FN2024	4
22	A	FN2224*	1
25	A	FN2524	1
30	A	FN3024	1



\* Disponibile fino ad esaurimento scorte • Available till sold out • Disponible jusqu'à épuisement du stock • Solange vorrat reicht

LINEA AIR  
Flessibile alluminio

A

Alluminio naturale • Natural aluminium  
Aluminium naturel • Aluminium natur

Z

Zincato • Galvanised  
Galvanisé • Verzinkt

# Tubi flessibili in rotoli da 10 metri (sp. 0,12mm)

in alluminio naturale

Aluminium Flexible pipes in rolls  
(10 meters) THK. 0.12 mmTubes flexibles en aluminium  
en rouleau de 10 mètres (EP.=0,12 mm)Aluminium-Flexrohre  
in 10-m-Rollen (Stärke 0,12 mm)

Prezzi al rotolo di 10 metri

Prices per 10 metre-roll

Prix au rouleau de 10 mètres

Preise pro 10-m-Rolle

Øcm	color	cod.	Pack
5	A	FN524	1
6	A	FN624	1



# Raccordi M/M per tubi flessibili

zincati

Galvanised M/M fittings  
for aluminium flexible pipesRaccords mâle-mâle galvanisés  
pour tubes flexibles en aluminiumVerzinkte Anschlussstücke  
Außengewinde/Außengewinde

Øcm	color	cod.	Pack
8	Z	Z817M	6
10	Z	Z1017M	6
12	Z	Z1217M	6
13	Z	Z1317M	6



Le foto contenute nel presente catalogo sono puramente indicative.  
Il produttore si riserva in qualsiasi momento, per motivi commerciali o produttivi,  
di modificare o eliminare gli articoli, i prezzi e le informazioni  
contenute nel presente catalogo, senza alcun preavviso.



[www.savefumisteria.it](http://www.savefumisteria.it)

**save**

LEADER ITALIANO PER LO SCARICO DEI FUMI