



LINEA

Wood

**La linea di tubi specifica
per stufe a legna**

**Range of flue pipes specially
designed for wood stoves**



LINEA WOOD

Plus 1,2 mm



Tubi per stufe a legna porcellanati
Vitreous enamelled pipes for wood stove
Tubes émaillé pour poêles à bois
Emaillierte Rohre für Holzofen



GAMMA COLORI COLOR RANGE



Nero opaco
Matt black
Noir mat
Mattschwarz

SPESSORE THICKNESS

TUBI LINEARI - LINEAR PIPES
1000mm, 500mm, 250mm, tubi telescopici

RACCORDERIA - FITTING PIPES
gomiti 90°, gomiti 45°, tubi a T, raccordi...

spessore totale
total thickness **1.2 mm**

acciaio 1 mm + smalto 0.2 mm
steel 1 mm + vitreous coating 0.2 mm

CARATTERISTICHE FEATURES

Rappresentano il massimo qualitativo della produzione SAVE Spa: tubi in acciaio al carbonio saldati a laser per ottenere saldature perfette, vengono successivamente ricoperti internamente ed esternamente con smalto vetroporcellanato cotto a temperatura di 850°C per conferire eccezionali qualità di resistenza alla corrosione delle condense di combustione.

I risultati del test V2 previsto dalla norma 1856-2 sulla resistenza alla corrosione, hanno dimostrato che i canali da fumo Plus 1.2mm e Plus Light hanno una durata decisamente superiore ai normali tubi verniciati di sp. 2mm non vetrificati internamente.

Resistono perfettamente anche a situazioni estreme come il fuoco di fuliggine (incendio che avviene dentro il tubo) senza rovinarsi o alterarsi.

La Dichiarazione di Prestazioni (DoP) n°2 Plus 1,2mm è disponibile sul sito www.savefumisteria.it alla pagina "download", con tutti i riferimenti ai test eseguiti e le istruzioni di montaggio e manutenzione a garanzia di assoluta sicurezza nell'utilizzo.

SUL NOSTRO SITO www.savefumisteria.it SONO DISPONIBILI INFORMAZIONI PIÙ DETTAGLIATE SU OGNI SINGOLO PRODOTTO.

Representing the highest level of SAVE Spa quality, laser-welding ensures these carbon steel pipes perfect welding. Subsequent internal/external vitreous enamel coating baked to 850°C provides exceptional resistance against corrosion by combustion condensate.

V2 test results specified by corrosion resistance Standard 1856-2 show that Plus 1.2 mm and Plus Light flue pipes have a significantly longer duration than normally painted 2 mm thick pipes that have not received internal vitreous enamel coating.

They are perfectly resistant even to extreme situations such as soot-fire (a fire that occurs inside the pipe) without being damaged or modified.

The Declaration of Performance (DoP) n°2 Plus 1,2mm is available at www.savefumisteria.it in the download area, with reference to all the tests performed and Installation and Maintenance Instructions to ensure the greatest safety during use.

MORE DETAILED INFORMATION ABOUT EACH PRODUCTS ARE AVAILABLE ON OUR WEBSITE www.savefumisteria.it

ANTICONDENSA ANTI-CONDENSATE

Per evitare la fuoriuscita di condensa è necessario che vengano montati con l'imbocco rivolto verso il basso (vedi disegno). Per fare questo può essere necessario usare come partenza il raccordo F/F anticondensa.

In order to prevent the leakage of condensate, they must be fitted with the inlet facing downwards (see drawing). To do this, it may be necessary to use an F/F anti-condensate fitting to start with.

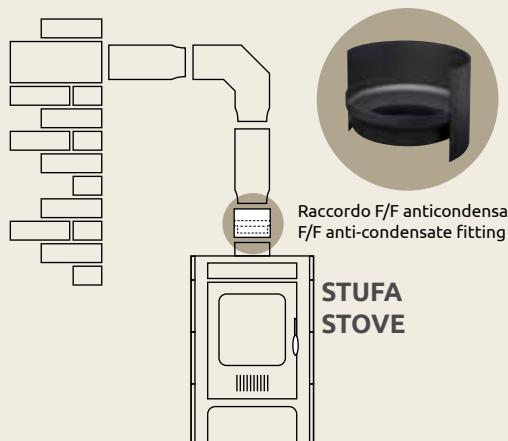

DESIGNAZIONI DESIGNATION

⊕ EN 1856-2 – T600 – N1 – W – V2 – L80120 – G600NM

⊕ EN 1856-2 – T450 – N1 – W – V2 – L80120 – O450

spessore totale **1.2 mm**

Tubi Plus *1,2 mm*

porcellanati in nero opaco

Plus matt black vitreous enamelled pipes

Tubes émaillés Plus en noir mat

Mattschwarz emailierte Plus Rohre

Ømm	color	L 1000mm		L 500mm		L 250mm	
		cod.	Pack	cod.	Pack	cod.	Pack
100	N	NNO1000	4	NNO1001	4	NNO1002	4
120	N	NNO1200	4	NNO1201	4	NNO1202	4
125	N	NNO12500	4	NNO12501	4	NNO12502	4
130	N	NNO1300	4	NNO1301	4	NNO1302	4
140	N	NNO1400	4	NNO1401	4	NNO1402	4
150	N	NNO1500	4	NNO1501	4	NNO1502	4
153	N	NNO15300	4	NNO15301	4	NNO15302	4
160	N	NNO1600	1	NNO1601	1	NNO1602	1
180	N	NNO1800	1	NNO1801	1	NNO1802	1
200	N	NNO2000	1	NNO2001	1	NNO2002	1



spessore totale 1.2 mm

Tubi telescopici H500mm e H330mm Plus 1,2 mm

porcellanati in nero opaco

Plus matt black vitreous enamelled telescopic pipes h. 500 mm and h. 330 mm

Tubes émaillés télescopiques Plus h 500 mm et h 330 mm en noir mat

Ausziehbare emailierte Plus Rohre (h 500 mm und h 330 mm) in mattschwarz

Ømm	color	H 500mm		H 330mm	
		cod.	Pack	cod.	Pack
120	N	-	-	NNO1220	1
125	N	NNO12521*	1	NNO12520	1
130	N	-	-	NNO1320	1
140	N	-	-	NNO1420	1
150	N	NNO1521	1	NNO1520	1
153	N	NNO15321*	1	NNO15320	1
160	N	-	-	NNO1620*	1
180	N	NNO1821*	1	NNO1820	1
200	N	NNO2021*	1	NNO2020	1



Disponibile fino ad esaurimento scorte • Available till sold out • Disponible jusqu'à épuisement du stock • Solange vorrat reicht

spessore totale 1.2 mm

Tubi con ispezione Plus 1,2 mm

porcellanati in nero opaco

Plus matt black vitreous enamelled pipes with inspection

Tubes émaillés Plus en noir mat avec trappe de visite

Mattschwarz emailierte Plus Rohre und Reinigungsöffnung

Ømm	color	L 1000 mm		L 500 mm		L 330 mm	
		cod.	Pack	cod.	Pack	cod.	Pack
125	N	NNO125008	1	NNO125018	1	NNO125028*	1
150	N	NNO15008	1	NNO15018	1	NNO15028*	1
180	N	NNO18008	1	NNO18018	1	NNO18028*	1



L 1000 mm



Disponibile fino ad esaurimento scorte • Available till sold out • Disponible jusqu'à épuisement du stock • Solange vorrat reicht

spessore totale **1.2 mm**

Gomiti Plus 1,2 mm

porcellanati in nero opaco

Plus matt black vitreous enamelled
90°, 45°, 30° and 15° elbows

Coudes émaillés Plus 90°, 45°, 30°
et 15° en noir mat

Mattschwarz emailierte Plus Knie
mit 90°, 45°, 30°, 15°-Winkel

		90°		45°		30°		15°	
Ømm	color	cod.	Pack	cod.	Pack	cod.	Pack	cod.	Pack
100	N	NNO1003	4	NNO1004	4	-	-	-	-
120	N	NNO1203	4	NNO1204	4	-	-	-	-
125	N	NNO12503	4	NNO12504	4	NNO12543	4	NNO12544	4
130	N	NNO1303	4	NNO1304	4	-	-	-	-
140	N	NNO1403	4	NNO1404	4	-	-	-	-
150	N	NNO1503	4	NNO1504	4	NNO1543	4	NNO1544	4
153	N	NNO15303	4	NNO15304	4	-	-	-	-
160	N	NNO1603	1	NNO1604	1	-	-	-	-
180	N	NNO1803	1	NNO1804	1	-	-	-	-
200	N	NNO2003	1	NNO2004	1	-	-	-	-



spessore totale 1.2 mm

Gomiti con ispezione Plus 1,2 mm

porcellanati in nero opaco

Plus matt black vitreous enamelled 90° with inspection
and 45° with inspection elbows

Coudes émaillés Plus 90° avec trappe de visite et 45°
avec trappe de visite en noir mat

Mattschwarz emailierte Plus Knie
mit 90°- und 45°-Winkel und Reinigungsöffnung

		90°		45°	
Ømm	color	cod.	Pack	cod.	Pack
100	N	NNO1008*	1	NNO10048*	1
120	N	NNO1208	1	-	-
125	N	NNO12508	1	NNO125048	1
130	N	NNO1308	1	-	-
150	N	NNO1508	1	NNO15048	1
153	N	NNO15308	1	-	-
180	N	NNO1808	1	NNO18048*	1



* Disponibile fino ad esaurimento scorte • Available till sold out • Disponible jusqu'à épuisement du stock • Solange vorrat reicht

spessore totale 1.2 mm

Tubi per disassamento Plus 1,2 mm

porcellanati in nero opaco

Plus matt black vitreous
enamelled offset pipes

Tubes émaillés Plus
en noir mat décalés

Mattschwarz emailierte
Plus Offset-Rohre

Ømm	color	cod.	Pack
125	N	NNO125OFF	1
150	N	NNO150OFF	1



spessore totale **1.2 mm**

Tubi a "T" Plus 1,2 mm

porcellanati in nero opaco,
nero ultra matt e grigio

Plus matt black, ultra matt black and grey vitreous enamelled
female-female or male-female T-pieces

Tés émaillés Plus femelle-femelle ou mâle-femelle
en noir mat, noir ultra mat et gris

Mattschwarz, ultra mattschwarz und grau emailierte Plus
T-Stücke Innengewinde/Innengewinde
oder Außengewinde/Innengewinde

Ømm	color	F/F		M/F	
		cod.	Pack	cod.	Pack
120	N	NNO1205F	1	-	-
125	N	NNO12505F	1	NNO12505M	1
130	N	NNO1305F	1	-	-
140	N	NNO1405F	1	-	-
150	N	NNO1505F	1	NNO1505M	1
153	N	NNO15305F	1	-	-
180	N	NNO1805F	1	NNO1805M*	1
200	N	NNO2005F	1	-	-



Disponibile fino ad esaurimento scorte • Available till sold out • Disponible jusqu'à épuisement du stock • Solange vorrat reicht

Pellet

Pellet
LIGHT

Pellet
Ultra Matt

Pellet
Ultra Matt

Accessori
Pellet

Plus
1,2mm

spessore totale **1.2 mm**

Tappi ciechi per tubi a "T" Plus *1,2 mm*

porcellanati in nero opaco,
nero ultra matt e grigio

Plus matt black, ultra matt black and grey vitreous
enamelled Blind covers for plus 1.2mm T-pieces

Tampons borgnes pour tés plus 1,2mm émaillés
en noir mat, noir ultra mat et gris

Mattschwarz, ultra mattschwarz und grau emailierte
Blindstopfen für T-Stücke plus 1,2mm

Ømm	color	cod.	Pack
120	N	NNO1219C	1
125	N	NNO12519C	1
130	N	NNO1319C	1
140	N	NNO1419C	1
150	N	NNO1519C	1
153	N	NNO15319C	1
180	N	NNO1819C	1
200	N	NNO2019C	1



spessore totale **1.2 mm**

Tubi con serranda H 250mm Plus *1,2 mm*

porcellanati in nero opaco

Plus matt black and vitreous enamelled
pipes with flue damper h. 250 mm

Tubes émaillés Plus en noir mat
avec registre h 250 mm

Mattschwarz emailierte Plus
Rohre mit Schieber, h 250 mm

Ømm	color	cod.	Pack
120	N	NNO1206	1
125	N	NNO12506	1
130	N	NNO1306	1
150	N	NNO1506	1
153	N	NNO15306*	1
180	N	NNO1806	1



Disponibile fino ad esaurimento scorte • Available till sold out • Disponible jusqu'à épuisement du stock • Solange vorrat reicht

spessore totale **1.2 mm**

Raccordi Plus *1,2 mm*

porcellanati in nero opaco

Plus matt black vitreous enamelled
female-female or male-male fittings h. 120 mm

Raccords émaillés Plus femelle-femelle
ou mâle-mâle h 120 mm en noir mat

Mattschwarz emailierte Plus Anschlussstücke
Innengewinde/Innengewinde oder
Außengewinde/Außengewinde (h120 mm)

		F/F		M/M	
Ømm	color	cod.	Pack	cod.	Pack
100	N	NNO1017F*	2	NNO1017M*	2
120	N	NNO1217F	2	-	-
125	N	NNO12517F	2	NNO12517M	2
130	N	NNO1317F	2	-	-
140	N	NNO1417F*	2	-	-
150	N	NNO1517F	2	NNO1517M	2
153	N	NNO15317F*	2	NNO15317M*	2
160	N	NNO1617F*	2	-	-
180	N	NNO1817F	2	NNO1817M*	2



* Disponibile fino ad esaurimento scorte • Available till sold out • Disponible jusqu'à épuisement du stock • Solange vorrat reicht

LINEA WOOD

Plus LIGHT



Tubi per stufe a legna porcellanati
Vitreous enamelled pipes for wood stove
Tubes émaillé pour poêles à bois
Emaillierte Rohre für Holzofen



GAMMA COLORI COLOR RANGE



Nero opaco
Matt black
Noir mat
Mattschwarz

SPESSORE THICKNESS

TUBI LINEARI - LINEAR PIPES
1000mm, 500mm, 250mm, tubi telescopici

spessore totale total thickness 0.7 mm

acciaio 0.5 mm + smalto 0.2 mm
steel 0.5 mm + vitreous coating 0.2 mm

RACCORDERIA - FITTING PIPES
gomiti 90°, gomiti 45°, tubi a T, raccordi...

spessore totale total thickness 1.2 mm

acciaio 1 mm + smalto 0.2 mm
steel 1 mm + vitreous coating 0.2 mm

CARATTERISTICHE FEATURES

Questi tubi sono più leggeri ed economici rispetto alla linea Plus 1,2mm, pur mantenendo tutte le caratteristiche normative e prestazionali. Sono perfettamente compatibili sia dal punto di vista tecnico per imbrocchi e dimensioni, sia dal punto di vista estetico per l'uguale finitura in smalto porcellanato. Su questi tubi si possono utilizzare gomiti e T della linea Plus 1,2mm oppure gomiti della linea Classic.

These pipes are lighter and less expensive than the Plus 1.2mm line, while maintaining all the characteristics and performance standards. They are fully compatible from both the technical point of view - thanks to the same connections and dimensions - and the aesthetic point of view, thanks to the same enamel coating. These pipes can be fitted with Plus 1.2 mm line elbows and tees or Classic line elbows.

Rappresentano il massimo qualitativo della produzione SAVE Spa: tubi in acciaio al carbonio saldati a laser per ottenere saldature perfette, vengono successivamente ricoperti internamente ed esternamente con smalto vetroporcellanato cotto a temperatura di 850°C per conferire eccezionali qualità di resistenza alla corrosione delle condense di combustione.

Representing the highest level of SAVE Spa quality, laser-welding ensures these carbon steel pipes perfect welding. Subsequent internal/external vitreous enamel coating baked to 850°C provides exceptional resistance against corrosion by combustion condensate.

I risultati del test V2 previsto dalla norma 1856-2 sulla resistenza alla corrosione, hanno dimostrato che i canali da fumo Plus 1.2mm e Plus Light hanno una durata decisamente superiore ai normali tubi verniciati di sp. 2mm non vetrificati internamente.

V2 test results specified by corrosion resistance Standard 1856-2 show that Plus 1.2 mm and Plus Light Flue pipes have a significantly longer duration than normally painted 2 mm thick pipes that have not received internal vitreous enamel coating.

Resistono perfettamente anche a situazioni estreme come il fuoco di fuliggine (incendio che avviene dentro il tubo) senza rovinarsi o alterarsi.

They are perfectly resistant even to extreme situations such as soot-fire (a fire that occurs inside the pipe) without being damaged or modified.

La Dichiarazione di Prestazioni (DoP) n°6 Plus Light è disponibile sul sito www.savefumisteria.it alla pagina "download", con tutti i riferimenti ai test eseguiti e le istruzioni di montaggio e manutenzione a garanzia di assoluta sicurezza nell'utilizzo.

The Declaration of Performance (DoP) n°6 Plus Light is available at www.savefumisteria.it in the download area, with reference to all the tests performed and Installation and Maintenance Instructions to ensure the greatest safety during use.

SUL NOSTRO SITO www.savefumisteria.it SONO DISPONIBILI INFORMAZIONI PIÙ DETTAGLIATE SU OGNI SINGOLO PRODOTTO.

MORE DETAILED INFORMATION ABOUT EACH PRODUCTS ARE AVAILABLE ON OUR WEBSITE www.savefumisteria.it

ANTICONDENSA ANTI-CONDENSATE

Per evitare la fuoriuscita di condensa è necessario che vengano montati con l'imbocco rivolto verso il basso (vedi disegno). Per fare questo può essere necessario usare come partenza il raccordo F/F anticondensa.

DESIGNAZIONI DESIGNATION

In order to prevent the leakage of condensate, they must be fitted with the inlet facing downwards (see drawing). To do this, it may be necessary to use an F/F anti-condensate fitting to start with.

- Ⓒ EN 1856-2 – T600 – N1 – W – V2 – L80070 – G450NM
- Ⓒ EN 1856-2 – T450 – N1 – W – V2 – L80070 – O350

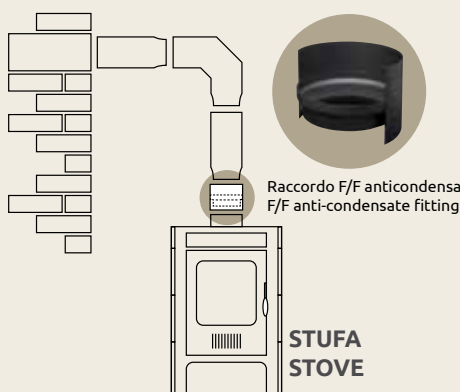

spessore totale **0.7 mm**

Tubi Plus **LIGHT**

porcellanati in nero opaco

Plus Light matt black vitreous enamelled pipes

Tubes émaillés Plus Light en noir mat

Mattschwarz emailierte Plus Rohre

		L 1000mm		L 500mm		L 250mm	
Ømm	color	cod.	Pack	cod.	Pack	cod.	Pack
120	N	NNOL1200	6	NNOL1201	6	NNOL1202	6
125	N	NNOL12500	6	NNOL12501	6	NNOL12502	6
130	N	NNOL1300	6	NNOL1301	6	NNOL1302	6
140	N	NNOL1400	6	NNOL1401	6	NNOL1402	6
150	N	NNOL1500	6	NNOL1501	6	NNOL1502	6
153	N	NNOL15300*	6	NNOL15301*	6	NNOL15302*	6



* Disponibile fino ad esaurimento scorte • Available till sold out • Disponible jusqu'à épuisement du stock • Solange vorrat reicht

spessore totale **0.7 mm**

Tubi telescopici H500mm e H330mm Plus **LIGHT**

porcellanati in nero opaco

Plus Light matt black vitreous enamelled
telescopic pipes h. 500 mm and h. 330 mm

Tubes émaillés télescopiques Plus
h 500 mm et h 330 mm en noir mat

Ausziehbare emaillierte Plus Rohre
(h 500 mm und h 330 mm) in mattschwarz

H 500mm				H 330mm	
Ømm	color	cod.	Pack	cod.	Pack
125	N	NNOL12521*	1	NNOL12520*	1
150	N	NNOL1521*	1	NNOL1520*	1
153	N	NNOL15321*	1	NNOL15320*	1

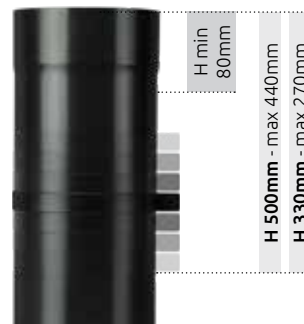

Disponibile fino ad esaurimento scorte • Available till sold out • Disponible jusqu'à épuisement du stock • Solange vorrat reicht

spessore totale **1.2 mm**

Gomiti Plus **1,2 mm**

porcellanati in nero opaco

Plus matt black vitreous enamelled
90°, 45°, 30° and 15° elbows

Coudes émaillés Plus
90°, 45°, 30° et 15° en noir mat

Mattschwarz emaillierte Plus Knie
mit 90°, 45°, 30°, 15°-Winkel

90°				45°		30°		15°	
Ømm	color	cod.	Pack	cod.	Pack	cod.	Pack	cod.	Pack
120	N	NNO1203	4	NNO1204	4	-	-	-	-
125	N	NNO12503	4	NNO12504	4	NNO12543	4	NNO12544	4
130	N	NNO1303	4	NNO1304	4	-	-	-	-
140	N	NNO1403	4	NNO1404	4	-	-	-	-
150	N	NNO1503	4	NNO1504	4	NNO1543	4	NNO1544	4
153	N	NNO15303	4	NNO15304	4	-	-	-	-



spessore totale **1.2 mm**

Gomiti con ispezione Plus *1,2 mm*

porcellanati in nero opaco

Plus matt black vitreous enamelled
90° with inspection and 45° with
inspection elbows

Coudes émaillés Plus
90° avec trappe de visite et
45° avec trappe de visite en noir mat

Mattschwarz emaillierte Plus Knie
mit 90°- und 45°-Winkel und Reinigungsöffnung

		90°		45°	
Ømm	color	cod.	Pack	cod.	Pack
120	N	NNO1208	1	-	-
125	N	NNO12508	1	NNO125048	1
130	N	NNO1308	1	-	-
150	N	NNO1508	1	NNO15048	1
153	N	NNO15308	1	-	-



spessore totale **1.2 mm**

Tubi a "T" Plus **1,2 mm**

porcellanati in nero opaco

Plus matt black vitreous enamelled
female-female or male-female T-pieces

Tés émaillés Plus femelle-femelle
ou mâle-femelle en noir mat

Mattschwarz emailierte Plus
T-Stücke Innengewinde/Innengewinde
oder Außengewinde/Innengewinde

		F/F		M/F	
Ømm	color	cod.	Pack	cod.	Pack
120	N	NNO1205F	1	-	-
125	N	NNO12505F	1	NNO12505M	1
130	N	NNO1305F	1	-	-
140	N	NNO1405F	1	-	-
150	N	NNO1505F	1	NNO1505M	1
153	N	NNO15305F	1	-	-



spessore totale **1.2 mm**

Tappi ciechi per tubi a "T" Plus **1,2 mm**

porcellanati in nero opaco

Plus matt black vitreous enamelled
Blind covers for Plus 1.2mm T-pieces

Tampons borgnes pour tés Plus 1,2mm
émaillés en noir mat

Mattschwarz emailierte Blindstopfen
für T-Stücke Plus 1,2mm

Ømm	color	cod.	Pack
120	N	NNO1219C	1
125	N	NNO12519C	1
130	N	NNO1319C	1
140	N	NNO1419C	1
150	N	NNO1519C	1
153	N	NNO15319C	1



spessore totale 1.2 mm

Tubi con serranda H 250mm Plus 1,2 mm

porcellanati in nero opaco

Plus matt black and vitreous enamelled
pipes with flue damper h. 250 mm

Tubes émaillés Plus en noir mat
avec registre h 250 mm

Mattschwarz emailierte Plus
Rohre mit Schieber, h 250 mm

Ømm	color	cod.	Pack
120	N	NNO1206	1
125	N	NNO12506	1
130	N	NNO1306	1
150	N	NNO1506	1
153	N	NNO15306*	1



Disponibile fino ad esaurimento scorte • Available till sold out • Disponible jusqu'à épuisement du stock • Solange vorrat reicht

spessore totale 1.2 mm

Raccordi Plus 1,2 mm

porcellanati in nero opaco

Plus matt black vitreous enamelled
female-female or male-male fittings h.120mm

Raccords émaillés Plus femelle-femelle
ou mâle-mâle h 120mm en noir mat

Mattschwarz emailierte Plus
Anschlussstücke Innengewinde/Innengewinde
oder Außengewinde/Außengewinde (h120 mm)

Ømm	color	F/F		M/M	
		cod.	Pack	cod.	Pack
120	N	NNO1217F	2	-	-
125	N	NNO12517F	2	NNO12517M	2
130	N	NNO1317F	2	-	-
140	N	NNO1417F*	2	-	-
150	N	NNO1517F	2	NNO1517M	2
153	N	NNO15317F*	2	NNO15317M*	2



Disponibile fino ad esaurimento scorte • Available till sold out • Disponible jusqu'à épuisement du stock • Solange vorrat reicht

LINEA WOOD

Plus 1,2 mm Ultra Matt



Tubi per stufe a legna porcellanati
Vitreous enamelled pipes for wood stove
Tubes émaillé pour poêles à bois
Emaillierte Rohre für Holzofen



GAMMA COLORI COLOR RANGE

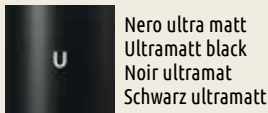

Nero ultra matt
Ultramatt black
Noir ultramat
Schwarz ultramatt

SPESSORE THICKNESS

TUBI LINEARI - LINEAR PIPES
1000mm, 500mm, 250mm, tubi telescopici

RACCORDERIA - FITTING PIPES
gomiti 90°, gomiti 45°, tubi a T, raccordi...

spessore totale
total thickness **1.2 mm**

acciaio 1 mm + smalto 0.2 mm
steel 1 mm + vitreous coating 0.2 mm

CARATTERISTICHE FEATURES

Rappresentano il massimo qualitativo della produzione SAVE Spa: tubi in acciaio al carbonio saldati a laser per ottenere saldature perfette, vengono successivamente ricoperti internamente ed esternamente con smalto vetroporcellanato cotto a temperatura di 850°C per conferire eccezionali qualità di resistenza alla corrosione delle condense di combustione.

I risultati del test V2 previsto dalla norma 1856-2 sulla resistenza alla corrosione, hanno dimostrato che i canali da fumo Plus 1.2mm e Plus Light hanno una durata decisamente superiore ai normali tubi verniciati di sp. 2mm non vetrificati internamente.

Resistono perfettamente anche a situazioni estreme come il fuoco di fuliggine (incendio che avviene dentro il tubo) senza rovinarsi o alterarsi.

La Dichiarazione di Prestazioni (DoP) n°2 Plus 1,2mm è disponibile sul sito www.savefumisteria.it alla pagina "download", con tutti i riferimenti ai test eseguiti e le istruzioni di montaggio e manutenzione a garanzia di assoluta sicurezza nell'utilizzo.

SUL NOSTRO SITO www.savefumisteria.it SONO DISPONIBILI INFORMAZIONI PIÙ DETTAGLIATE SU OGNI SINGOLO PRODOTTO.

Representing the highest level of SAVE Spa quality, laser-welding ensures these carbon steel pipes perfect welding. Subsequent internal/external vitreous enamel coating baked to 850°C provides exceptional resistance against corrosion by combustion condensate.

V2 test results specified by corrosion resistance Standard 1856-2 show that Plus 1.2 mm and Plus Light flue pipes have a significantly longer duration than normally painted 2 mm thick pipes that have not received internal vitreous enamel coating.

They are perfectly resistant even to extreme situations such as soot-fire (a fire that occurs inside the pipe) without being damaged or modified.

The Declaration of Performance (DoP) n°2 Plus 1,2mm is available at www.savefumisteria.it in the download area, with reference to all the tests performed and Installation and Maintenance Instructions to ensure the greatest safety during use.

MORE DETAILED INFORMATION ABOUT EACH PRODUCTS ARE AVAILABLE ON OUR WEBSITE www.savefumisteria.it

ANTICONDENSA ANTI-CONDENSATE

Per evitare la fuoriuscita di condensa è necessario che vengano montati con l'imbocco rivolto verso il basso (vedi disegno). Per fare questo può essere necessario usare come partenza il raccordo F/F anticondensa.

In order to prevent the leakage of condensate, they must be fitted with the inlet facing downwards (see drawing). To do this, it may be necessary to use an F/F anti-condensate fitting to start with.

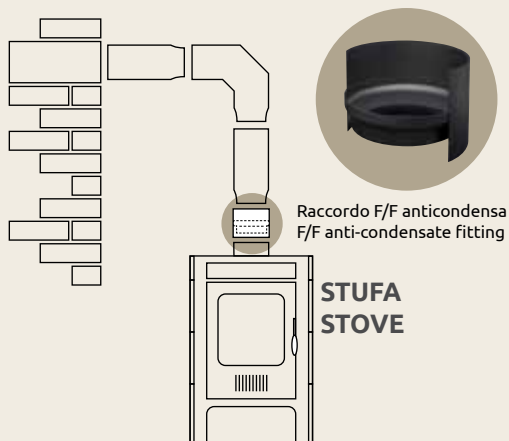

DESIGNAZIONI DESIGNATION

⊗ EN 1856-2 - T600 - N1 - W - V2 - L80120 - G600NM

⊗ EN 1856-2 - T450 - N1 - W - V2 - L80120 - O450

spessore totale 1,2 mm

Tubi Plus 1,2 mm Ultra Matt

porcellanati in nero ultra matt

Plus ultra matt black vitreous enamelled pipes
Tubes émaillés Plus en noir ultra mat
Ultra mattschwarz emailierte Plus Rohre

		L 1000 mm		L 500 mm		L 250 mm	
Ø mm	color	cod.	Pack	cod.	Pack	cod.	Pack
125	U	UU12500	4	UU12501	4	UU12502	4
150	U	UU1500	4	UU1501	4	UU1502	4



spessore totale 1,2 mm

Tubi telescopici H 330 mm Plus 1,2 mm Ultra Matt

porcellanati in nero ultra matt

Plus ultra matt black vitreous enamelled
telescopic pipes h. 330 mm
Tubes émaillés télescopiques Plus h 330 mm
en noir ultra mat
Ausziehbare emailierte Plus Rohre
(h 330 mm) in ultra mattschwarz

Ø mm	color	cod.	Pack
125	U	UU12520	1
150	U	UU1520	1

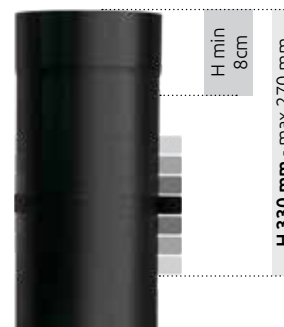

spessore totale **1.2 mm**

Gomiti Plus *1,2 mm* Ultra Matt

porcellanati in nero ultra matt

Plus ultra matt black vitreous enamelled 90° and 45° elbows

Coudes émaillés Plus 90° et 45° en noir ultra mat

Ultra mattschwarz emaillierte Plus Knie mit 90°- und 45°-Winkel

90°				45°	
Ø mm	color	cod.	Pack	cod.	Pack
125	U	UU12503	4	UU12504	4
150	U	UU1503	4	UU1504	4



spessore totale **1.2 mm**

Gomiti 90° con ispezione Plus *1,2 mm* Ultra Matt

porcellanati in nero ultra matt

Plus ultra matt black vitreous enamelled
90° with inspection elbows

Coudes émaillés Plus 90° avec
trappe de visite en noir ultra mat

Ultra mattschwarz emaillierte Plus Knie
mit 90°-Winkel und Reinigungsöffnung

Ø mm	color	cod.	Pack
150	U	UU1508*	1



Disponibile fino ad esaurimento scorte • Available till sold out • Disponible jusqu'à épuisement du stock • Solange vorrat reicht

spessore totale 1,2 mm

Tubi a "T" Plus 1,2 mm Ultra Matt

porcellanati in nero ultra matt

Plus ultra matt black and grey vitreous enamelled
female-female or male-female T-pieces

Tés émaillés Plus femelle-femelle
ou mâle-femelle en noir ultra mat

Ultra mattschwarz emailierte Plus
T-Stücke Innengewinde/Innengewinde
oder Außengewinde/Innengewinde

F/F				M/F		
Ø mm	color	cod.	Pack	cod.	Pack	
125	U	UU12505F	1	UU12505M*	1	
150	U	UU1505F	1	UU1505M*	1	

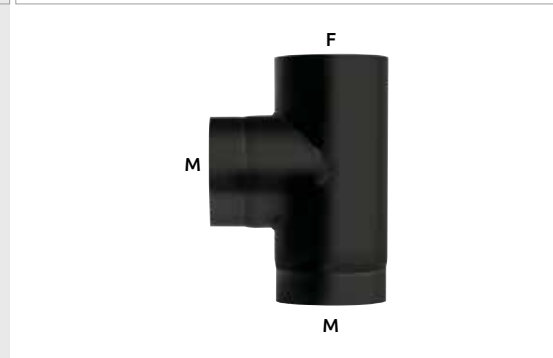

* Disponibile fino ad esaurimento scorte • Available till sold out • Disponible jusqu'à épuisement du stock • Solange vorrat reicht

spessore totale 1,2 mm

Tappi ciechi per tubi a "T" Plus 1,2 mm Ultra Matt

porcellanati in nero ultra matt

Plus ultra matt black vitreous enamelled
Blind covers for plus 1.2mm T-pieces

Tampons borgnes pour tés plus 1,2mm
émaillés en noir ultra mat

Ultra mattschwarz emailierte
Blindstopfen für T-Stücke plus 1,2mm

Ø mm	color	cod.	Pack
125	U	UU12519C	1
150	U	UU1519C	1



spessore totale **1.2 mm**

Raccordi Plus 1,2 mm Ultra Matt



porcellanati in nero ultra matt

Plus ultra matt black vitreous enamelled
female-female or male-male fittings h. 120 mm

Raccords émaillés Plus femelle-femelle ou mâle-mâle
h 120 mm en noir ultra mat

Ultra mattschwarz emailierte Plus
Anschlussstücke Innengewinde/Innengewinde
oder Außengewinde/Außengewinde (h120 mm)

		F/F		M/M	
Ø mm	color	cod.	Pack	cod.	Pack
125	U	UU12517F *	2	UU12517M *	2
150	U	UU1517F *	2	UU1517M *	2



* Disponibile fino ad esaurimento scorte • Available till sold out • Disponible jusqu'à épuisement du stock • Solange vorrat reicht

LINEA WOOD

Accessori Plus & Plus **LIGHT**

Accessori "PLUS & PLUS LIGHT" in nero opaco e nero ultra matt

Matt black and ultra matt black "PELLET" accessories

Accessoires "PELLET" en noir mat et noir ultra mat

Accessoires Baureihe "PELLET" in mattschwarz und ultra mattschwarz

GAMMA COLORI COLOR RANGE

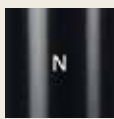

Nero opaco
Matt black
Noir mat
Mattschwarz



Nero ultra matt
Ultramatt black
Noir ultramat
Schwarz ultramatt

ATTENZIONE:

Tutti gli accessori verniciati sono compatibili con le finiture smaltate nero opaco e nero ultra matt.

ATTENTION:

All black painted accessories are compatible with vitreous enamelled finishes in matt black and ultra matt black.

AVERTISSEMENT:

Tous les accessoires en peinture noir sont compatibles avec les finitions en emaille noir matt et noir ultra matt.

ACHTUNG:

Alle schwarz lackierte Zubehöre sind kompatibel mit emallierte Rohre in mattschwarz und ultra mattschwarz.

CARATTERISTICHE FEATURES

Tutti gli Accessori Plus SAVE sono appositamente studiati per essere perfettamente adattabili alle linee Pellet, Pellet Light, Plus 1,2mm, Plus Light.

All the Plus SAVE accessories have been specifically designed to fit the Pellet, Pellet Light, Plus 1,2mm, Plus Light.

SUL NOSTRO SITO www.savefumisteria.it SONO DISPONIBILI INFORMAZIONI PIÙ DETTAGLIATE SU OGNI SINGOLO PRODOTTO.

MORE DETAILED INFORMATION ABOUT EACH PRODUCTS ARE AVAILABLE ON OUR WEBSITE www.savefumisteria.it

Pellet

Pellet
LIGHT

Pellet **LIGHT**
Ultra Matt

Pellet **FIT LIGHT**
Ultra Matt

Accessori
Pellet

Plus
1,2mm

Plus
LIGHT

Plus 1,2mm
Ultra Matt

Accessori
Plus

Questo accessorio è adatto ai prodotti della linea
This accessory is suitable for the products of the line

PLUS 1,2mm PLUS LIGHT

Anelli Plus

verniciati in nero opaco

Matt black painted Plus ring

Anneaux Plus laqués noir mat

Mattschwarz lackierte Plus Ringe

				90°	45°
Ømm	color	cod.	Pack	cod.	Pack
100	N	NN1010	10	-	-
120	N	NN1210	10	-	-
125	N	NN12510	10	NN12514	10
130	N	NN1310	10	-	-
140	N	NN1410	10	-	-
150 / 153	N	NN1510	10	NN1514	10
160	N	NN1610	10	-	-
180	N	NN1810	10	-	-
200	N	NN2010	10	-	-

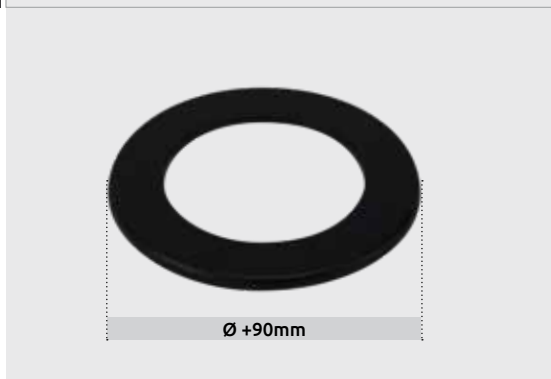

Questo accessorio è adatto ai prodotti della linea
This accessory is suitable for the products of the line

PLUS 1,2mm PLUS LIGHT

Kit fissaggio magnetico per anelli

Magnetic fixing kit for rings

Magnetic kit de montage pour les anneaux

Magnetischer Montage-Kit für Ringe

cod.	Pack
NNFIX	20



Questo accessorio è adatto ai prodotti della linea
This accessory is suitable for the products of the line

PLUS 1,2mm **Plus LIGHT**

Rosoni Plus

verniciati in nero opaco

Matt black painted Plus covers

Rosaces Plus laqués noir mat

Mattschwarz lackierte Plus Rosetten

Ømm	color	cod.	Pack
120	N	NN1209	5
130	N	NN1309	5
140	N	NN1409	5
150	N	NN1509	5
160	N	NN1609*	5
180	N	NN1809*	5
200	N	NN2009*	5



Disponibile fino ad esaurimento scorte • Available till sold out • Disponible jusqu'à épuisement du stock • Solange vorrat reicht

Questo accessorio è adatto ai prodotti della linea
This accessory is suitable for the products of the line

PLUS 1,2mm **Plus LIGHT**

Reggitubo Plus

verniciati in nero opaco

Matt black painted stainless steel Plus pipe holder

Porte-tubes Plus laqué noir mat

Mattschwarz lackierter Plus Rohrhalter mit Dübel

Ømm	color	cod.	Pack
100	N	NN210	10
120	N	NN212	10
130 / 125	N	NN213	10
140	N	NN214	10
150 / 153	N	NN215	10
160	N	NN216	10
180	N	NN218	10
200	N	NN220	10



Questo accessorio è adatto ai prodotti della linea
This accessory is suitable for the products of the line

Plus 1,2mm **Plus LIGHT**

Riduzioni Plus

porcellanate in nero opaco

Matt black vitreous enamelled Plus reducers

Réductions Plus émaillés noir mat

Mattschwarz emaillierte Plus Reduzierstücke

Øcm	color	cod.	Pack
200F / 180M	N	NNO20F/18M	2
200F / 150M	N	NNO20F/15M	2
180F / 150M	N	NNO18F/15M	2
160F / 150M	N	NNO16F/15M	2
153F / 150M	N	NNO153F/15M	2
150F / 140M	N	NNO15F/14M	2
150F / 130M	N	NNO15F/13M	2
150F / 125M	N	NNO15F/125M	2
150F / 120M	N	NNO15F/12M	2
140F / 130M	N	NNO14F/13M	2
130F / 120M	N	NNO13F/12M	2
125F / 130M	N	NNO125F/13M*	2



Disponibile fino ad esaurimento scorte • Available till sold out • Disponible jusqu'à épuisement du stock • Solange vorrat reicht

Questo accessorio è adatto ai prodotti della linea
This accessory is suitable for the products of the line

Plus 1,2mm **Plus LIGHT**

Raccordi telescopici a soffitto Plus

verniciati in nero opaco

Plus matt black painted
telescopic ceiling fittings

Raccords télescopiques Plus
plafond laqués noir mat

Ausziehbares Plus
Deckenanschlussstück,
mattschwarz lackiert

Ømm	color	cod.	Pack
150	N	NN1511	1



Questo accessorio è adatto ai prodotti della linea
This accessory is suitable for the products of the line

PLUS 1,2mm PLUS LIGHT

Raccordi F/F anticondensa Plus

porcellanati in nero opaco,
nero ultra matt

Matt black and ultra matt black vitreous enamelled Plus
female-female anti-condensate fittings

Raccords anticondensation Plus femelle-femelle émaillés
en noir mat and noir ultra mat

Anschlussstücke mit Kondensationsschutz Plus,
Innengewinde/Innengewinde, mattschwarz
und ultra mattschwarz emailierte

Ømm	color	cod.	Pack
120	N	NNO1231	2
125	N	NNO12531	2
	U	UU12531 *	2
130	N	NNO1331	2
140	N	NNO1431	2
150	N	NNO1531	2
	U	UU1531 *	2
153	N	NNO15331	2
180	N	NNO1831	2
200	N	NNO2031	2



Disponibile fino ad esaurimento scorte • Available till sold out • Disponible jusqu'à épuisement du stock • Solange vorrat reicht

Questo accessorio è adatto ai prodotti della linea
This accessory is suitable for the products of the line

PLUS 1,2mm PLUS LIGHT

Serrande Plus

verniciate in nero opaco

Plus matt black painted flue damper

Registre Plus laqué noir mat

Plus Schieber, mattschwarz lackiert

Ømm	color	cod.	Pack
120-130	N	NN12/1315	1
140-150-160	N	NN14/15/1615	1
180-200	N	NN18/2015	1



Pedane

in acciaio verniciato nero opaco
e vetro temperato

Matt black painted steel
and toughened glass bases

Bases en acier laqué noir mat
et verre trempé

Bodenplatten aus mattschwarz
lackiertem Stahl und Sekuritglas

1000x900 mm			800x600 mm			700x600 mm		
color	cod.	Pack	cod.	Pack	cod.	Pack		
N	P100/90*	1	-	-	P70/60*	1		
	-	-	PV80/60*	1	-	-		
								



Disponibile fino ad esaurimento scorte • Available till sold out • Disponible jusqu'à épuisement du stock • Solange vorrat reicht

Bombolette spray per ritocchi

colore nero opaco

Spray canisters for touch-ups (matt black)

Vaporisateurs pour retouches (noir mat)

Spraydosen zum Nachbessern (mattschwarz)

color	cod.	Pack
N	NNSPRAY	1



Coppelle di coibentazione

in lana di roccia
(lunghezza 1000 mm - spessore 30 mm)

Rock wool pipe insulators
(1mt long - 30 mm thick)

Couppelles d'isolement en laine de roche
(longueur 1mt - épaisseur 30 mm)

Dämmmantel - Steinwolle
(Länge 1 m - Stärke 30 mm)

Ømm	cod.	Pack
80	AA815	10
100	AA1015	8
120	AA1215	7
130	AA1315	7
140	AA1415*	7
150	AA1515	7



Disponibile fino ad esaurimento scorte • Available till sold out • Disponible jusqu'à épuisement du stock • Solange vorrat reicht

LINEA WOOD

Classic

Tubi porcellanati Classic in bianco, marrone e nero opaco
 Classic white, brown and matt black vitreous enamelled pipes
 Tubes émaillés Classic en blanc, marron et noir mat
 Weiß, braun und mattschwarz emaillierte Classic Rohre



GAMMA COLORI COLOR RANGE



Bianco
White
Blanc
Weiss

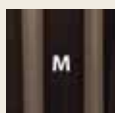

Marrone
Brown
Marron
Braun

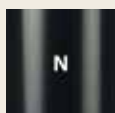

Nero opaco
Matt black
Noir mat
Mattschwarz

SPESSORE THICKNESS

TUBI LINEARI - LINEAR PIPES
1000mm, 500mm, 250mm

spessore totale
total thickness **0.55 mm**

RACCORDERIA - FITTING PIPES
gomiti 90°, gomiti 45°

acciaio 0.35 mm + smalto 0.2 mm
steel 0.35 mm + vitreous coating 0.2 mm

CARATTERISTICHE FEATURES

I tubi smaltati SAVE sono prodotti con lamiera di acciaio rivestita con smalto porcellanato tramite un procedimento che prevede la cottura del pezzo a ben 830°C.

Lo smalto porcellanato rende questo tubo preferibile ad ogni altro per alcune caratteristiche:

- resistenza alle più alte temperature di esercizio: T600, la classe più alta secondo la EN 1856-2
- resistenza allo sbalzo termico
- resistenza alla corrosione da condensa certificata dal superamento del test V2 che li rende idonei all'utilizzo con qualsiasi tipo di combustibile: solido, liquido e gassoso
- resistenza all'abrasione e agli agenti chimici: sono lavabili con qualsiasi solvente o prodotto per la pulizia.
- tenuta ai gas della combustione (tiraggio naturale)
- qualità estetica: i colori non si alterano con l'uso o con le alte temperature

La Dichiarazione di Prestazioni (DoP) n°1 Classic è disponibile sul sito www.savefumisteria.it alla pagina "download", con tutti i riferimenti ai test eseguiti e le istruzioni di montaggio e manutenzione a garanzia di assoluta sicurezza nell'utilizzo.

The SAVE vitreous enamelled pipes are made of sheet steel coated with vitreous enamel and baked at 830°C.

The vitreous enamel coating makes this pipe better than any other pipe thanks to some of its features:

- resistance to the highest working temperatures: T600, the highest class according to EN 1856-2
- resistance to any changes in temperature
- resistance to condensate corrosion certified by the outcome of the V2 test for qualification for use with any type of solid, liquid or gas fuel.
- resistance to abrasion and chemical agents; they can be cleaned with any solvent or cleaning product
- combustion gas-tight (natural draught)
- aesthetic quality: colours do not alter with use or as a result of high temperatures

The Declaration of Performance (DoP) n°1 Classic is available at www.savefumisteria.it in the download area, with reference to all the tests performed and Installation and Maintenance Instructions to ensure the greatest safety during use.

SUL NOSTRO SITO www.savefumisteria.it SONO DISPONIBILI INFORMAZIONI PIÙ DETTAGLIATE SU OGNI SINGOLO PRODOTTO.

MORE DETAILED INFORMATION ABOUT EACH PRODUCTS ARE AVAILABLE ON OUR WEBSITE www.savefumisteria.it

CAMPO DI APPLICAZIONE FIELD OF APPLICATION

APPARECCHI E STUFE A:

- Legna
- Carbone
- Gas
- Gasolio
- Kerosene

APPLIANCES AND STOVES:

- Wood-burning
- Coal
- Gas
- Gas oil
- Kerosene

DESIGNAZIONI DESIGNATION

€ EN 1856-2 - T600 - N1 - D - V2 - L80055 - G450NM

€ EN 1856-2 - T450 - N1 - D - V2 - L80055 - O350

Pellet

Pellet LIGHT

Pellet LIGHT Ultra Matt

Pellet FIT LIGHT Ultra Matt

Accessori Pellet

Plus 1,2mm

Plus LIGHT

Plus 1,2mm Ultra Matt

Accessori Plus

Classic

spessore totale **0.55 mm**

Tubi Classic

porcellanati in bianco,
marrone e nero opaco

Classic white, brown and matt black
vitreous enamelled pipes

Tubes émaillés Classic
en blanc, marron et noir mat
Weiß, braun und Mattschwarz
emailierte Classic Rohre

Ømm	color	L 1000mm		L 500mm		L 250mm	
		cod.	Pack	cod.	Pack	cod.	Pack
80	B	B800	12	B801	12	B802	12
	M	M800	12	M801	12	M802	12
90	B	B900	12	B901	12	B902	12
100	B	B1000	12	B1001	12	B1002	12
	M	M1000	12	M1001	12	M1002	12
	N	NO1000	12	NO1001	12	NO1002	12
120	B	B1200	12	B1201	12	B1202	12
	M	M1200	12	M1201	12	M1202	12
	N	NO1200	12	NO1201	12	NO1202	12
130	B	B1300	12	B1301	12	B1302	12
	M	M1300	12	M1301	12	M1302	12
	N	NO1300	12	NO1301	12	NO1302	12
140	B	B1400	6	B1401	6	B1402	6
	M	M1400	6	M1401	6	M1402	6
	N	NO1400	6	NO1401	6	NO1402	6
150	B	B1500	6	B1501	6	B1502	6
	M	M1500	6	M1501	6	M1502	6
	N	NO1500	6	NO1501	6	NO1502	6



spessore totale **0.55 mm**

Gomiti Classic

porcellanati in bianco,
marrone e nero opaco

Classic white, brown and matt black
vitreous enamelled 90° and 45° elbows

Coudes émaillés Classic 90° et 45°
en blanc, marron et noir mat

Weiß, braun und Mattschwarz
emailierte Classic 90°- und 45°-Knie

Ømm	color	90°		45°	
		cod.	Pack	cod.	Pack
80	B	B803	12	B804	12
	M	M803	12	M804	12
90	B	B903	12	-	-
100	B	B1003	12	B1004	12
	M	M1003	12	M1004	12
	N	NO1003	12	NO1004	12
120	B	B1203	12	B1204	12
	M	M1203	12	M1204	12
	N	NO1203	12	NO1204	12
130	B	B1303	12	B1304	12
	M	M1303	12	M1304	12
	N	NO1303	12	NO1304	12
140	B	B1403	6	B1404	6
	M	M1403	6	M1404	6
	N	NO1403	6	NO1404	6
150	B	B1503	6	B1504	6
	M	M1503	6	M1504	6
	N	NO1503	6	NO1504	6



spessore totale **0.55 mm**

Tubi H 250 mm con foro per serranda Classic

porcellanati in bianco, marrone e nero opaco

Classic white, brown and matt black vitreous enamelled drilled pipes for flue dampers (h=250 mm)

Tubes Classic ayant un trou pour le registre (h=250 mm) en blanc, marron et noir mat

Emaillierte Classic Rohre mit Öffnung für Schieber (H=250 mm) in weiß, braun und mattschwarz

Ømm	color	cod.	Pack
100	B	B1006*	12
120	B	B1206*	12
	M	M1206	12
	N	NO1206*	12



* Disponibile fino ad esaurimento scorte • Available till sold out • Disponible jusqu'à épuisement du stock • Solange vorrat reicht

Serrande

Galvanised flue dampers

Registres galvanisé

Verzinkte Schieber

zincate

Ømm	color	cod.	Pack
100	Z	Z1015*	1
120	Z	Z1215	1
130	Z	Z1315*	1
160	Z	Z1615*	1



* Disponibile fino ad esaurimento scorte • Available till sold out • Disponible jusqu'à épuisement du stock • Solange vorrat reicht

Rosoni Master Euroflues

verniciati in bianco, marrone,
nero e alluminati

Euroflues Master covers painted in white,
brown, black and aluminized steel

Rosaces Master Euroflues laquées blanc,
marron, noir et en acier aluminat

Weiß, braun, Schwarz lackierte und
Aluminatstahl Master Euroflues Rosetten

Ømm	color	cod.	Pack
80	B	EB809	10
	M	EM809	10
	N	EN809	10
	A	EA809	10
90	B	EB909	10
	A	EA909	10
100	B	EB1009	10
	M	EM1009	10
	N	EN1009	10
	A	EA1009	10
110	B	EB1109	10
	A	EA1109	10
120	B	EB1209	10
	M	EM1209	10
	N	EN1209	10
	A	EA1209	10
130	B	EB1309	10
	M	EM1309	10
	N	EN1309	10
	A	EA1309	10
140	B	EB1409	10
	M	EM1409	10
	N	EN1409	10
	A	EA1409	10
150	B	EB1509	10
	M	EM1509	10
	N	EN1509	10
	A	EA1509	10
160	B	EB1609	10
	A	EA1609	10
180	B	EB1809	10
	A	EA1809	10
200	B	EB2009	10
	A	EA2009	10



Riduzioni Master Euroflues

verniciate in bianco, marrone,
nero opaco e alluminio

Euroflues Master white, brown, matt black
painted and aluminium reducers
Réductions Master Euroflues laquées blanc,
marron, noir mat et en aluminium

Weiß, braun, mattschwarz lackierte und
Aluminium Master Euroflues reduzierstücke

Øcm	color	cod.	Pack
90F / 80M	B	EB9F/8M	10
	M	EM9F/8M	10
100F / 80M	B	EB10F/8M	10
	M	EM10F/8M	10
	N	ENO10F/8M	10
100F / 90M	B	EB10F/9M	10
110F / 80M	B	EB11F/8M*	10
	M	EM11F/8M*	10
110F / 90M	B	EB11F/9M	10
110F / 100M	B	EB11F/10M	10
	M	EM11F/10M	10
120F / 80M	B	EB12F/8M	10
	M	EM12F/8M	10
	N	ENO12F/8M	10
	A	EA12F/8M*	10
120F / 90M	B	EB12F/9M	10
	M	EM12F/9M*	10
	A	EA12F/9M*	10
120F / 100M	B	EB12F/10M	10
	M	EM12F/10M	10
	N	ENO12F/10M	10
	A	EA12F/10M	10
120F / 110M	B	EB12F/11M	10
	M	EM12F/11M	10
	N	ENO12F/11M*	10
	A	EA12F/11M*	10
130F / 80M	B	EB13F/8M	10
	A	EA13F/8M*	10
130F / 90M	B	EB13F/9M*	10
130F / 100M	B	EB13F/10M	10
	M	EM13F/10M	10
	N	ENO13F/10M	10

Øcm	color	cod.	Pack
130F / 110M	B	EB13F/11M	10
	M	EM13F/11M*	10
130F / 120M	B	EB13F/12M	10
	M	EM13F/12M	10
	N	ENO13F/12M	10
	A	EA13F/12M	10
140F / 80M	B	EB14F/8M	10
140F / 100M	B	EB14F/10M	10
	N	ENO14F/10M*	10
	A	EA14F/10M*	10
140F / 110M	B	EB14F/11M*	10
	M	EM14F/11M*	10
	A	EA14F/11M*	10
	A	EA14F/11M*	10
140F / 120M	B	EB14F/12M	10
	M	EM14F/12M	10
	N	ENO14F/12M	10
	A	EA14F/12M	10
140F / 130M	B	EB14F/13M	10
	M	EM14F/13M	10
	N	ENO14F/13M	10
	A	EA14F/13M*	10
150F / 120M	B	EB15F/12M	10
	M	EM15F/12M	10
	N	ENO15F/12M	10
	A	EA15F/12M	10
150F / 130M	B	EB15F/13M	10
	N	ENO15F/13M	10
	A	EA15F/13M*	10
150F / 140M	B	EB15F/14M	10
	N	ENO15F/14M	10
	A	EA15F/14M	10

Øcm	color	cod.	Pack
160F / 140M	B	EB16F/14M*	10
	M	EM16F/14M*	10
	N	ENO16F/14M*	10
	A	EA16F/14M*	10
160F / 150M	B	EB16F/15M*	10
	M	EM16F/15M*	10
180F / 150M	A	EA18F/15M*	10
180F / 160M	B	EB18F/16M*	10
	M	EM18F/16M*	10
200F / 180M	B	EB20F/18M*	10
	M	EM20F/18M*	10

Øcm	color	cod.	Pack
80F / 100M	B	EB8F/10M	10
	M	EM8F/10M	10
	N	ENO8F/10M	10
80F / 120M	B	EB8F/12M	10
	M	EM8F/12M	10
	N	ENO8F/12M	10
100F / 120M	B	EB10F/12M	10
	M	EM10F/12M	10
	N	ENO10F/12M	10
110F / 120M	B	EB11F/12M	10



* Disponibile fino ad esaurimento scorte • Available till sold out • Disponible jusqu'à épuisement du stock • Solange vorrat reicht

Pellet

Pellet
LIGHT

Pellet
LIGHT
Ultra Matt

Pellet **FIT LIGHT**
Ultra Matt

Accessori
Pellet

Plus
1,2mm

Plus
LIGHT

Plus 1,2mm
Ultra Matt

Accessori
Plus

Classic

Reggitubo Classic

verniciati in bianco,
marrone e nero

Classic white, brown and black
painted pipe holder

Porte-tubes à cheville Classic
laqué blanc, marron et noir

Lackierter Classic Rohrhalter mit Dübel
in weiß, braun und schwarz

Ømm	color	cod.	Pack
80 / 130	N	N28/13*	5
100 / 150	B	B210/15	5
	M	M210/15	5
	N	N210/15*	5



Disponibile fino ad esaurimento scorte • Available till sold out • Disponible jusqu'à épuisement du stock • Solange vorrat reicht

Stendibiancheria Classic

verniciati in bianco
e marrone

Classic white and brown
clothes drier

Séchoir à linge Classic
en blanc et marron

Classic Wäschetrockner
in weiß und braun

Ømm	color	cod.	Pack
80 / 140	B	B5	6
	M	M5*	6

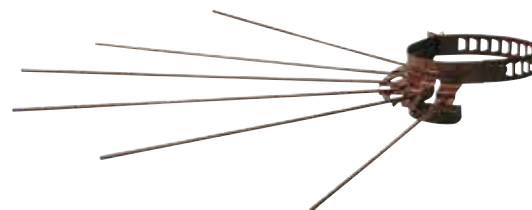

Disponibile fino ad esaurimento scorte • Available till sold out • Disponible jusqu'à épuisement du stock • Solange vorrat reicht